

3670

2100

1360

2240

2100

70x190

80x201.5

60x60

60x60

Grundplan

A

B

C

1

2

750

600

750

700

700

600

300

800

200

200

Fundament

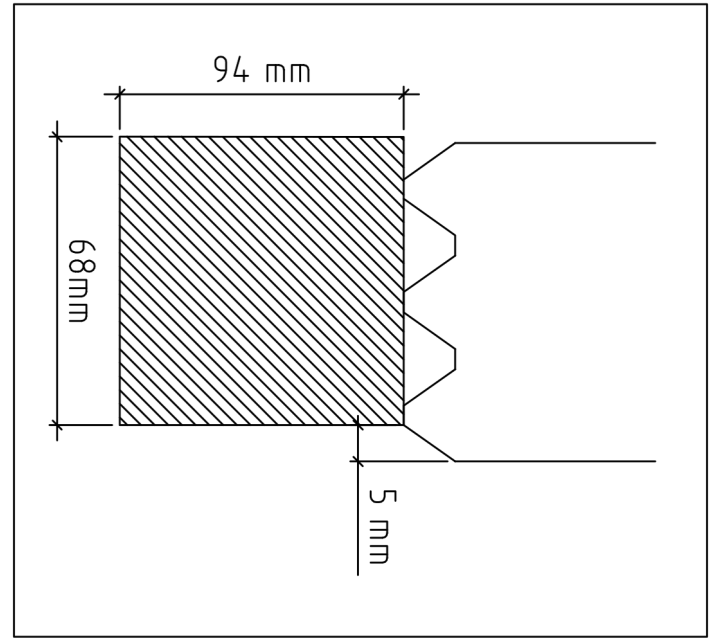
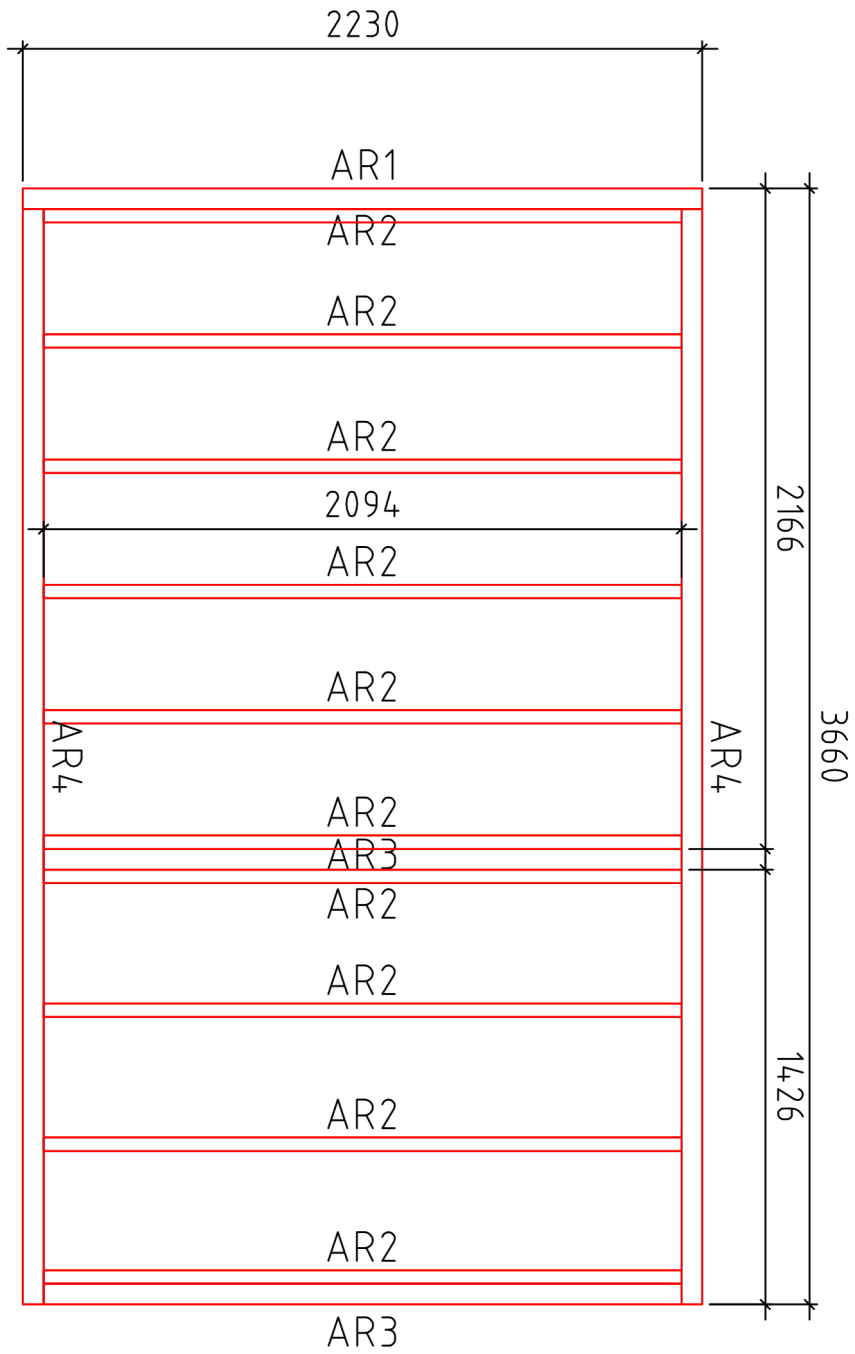

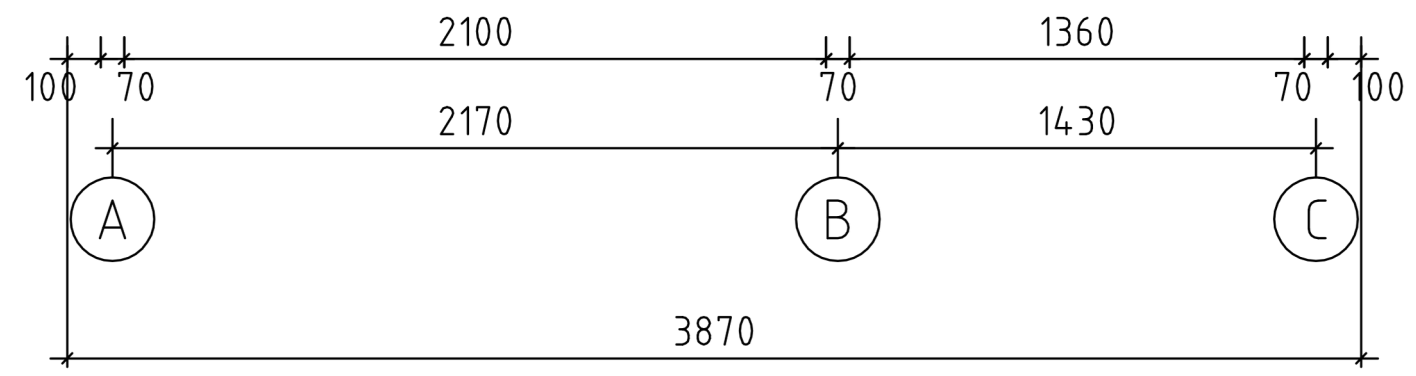
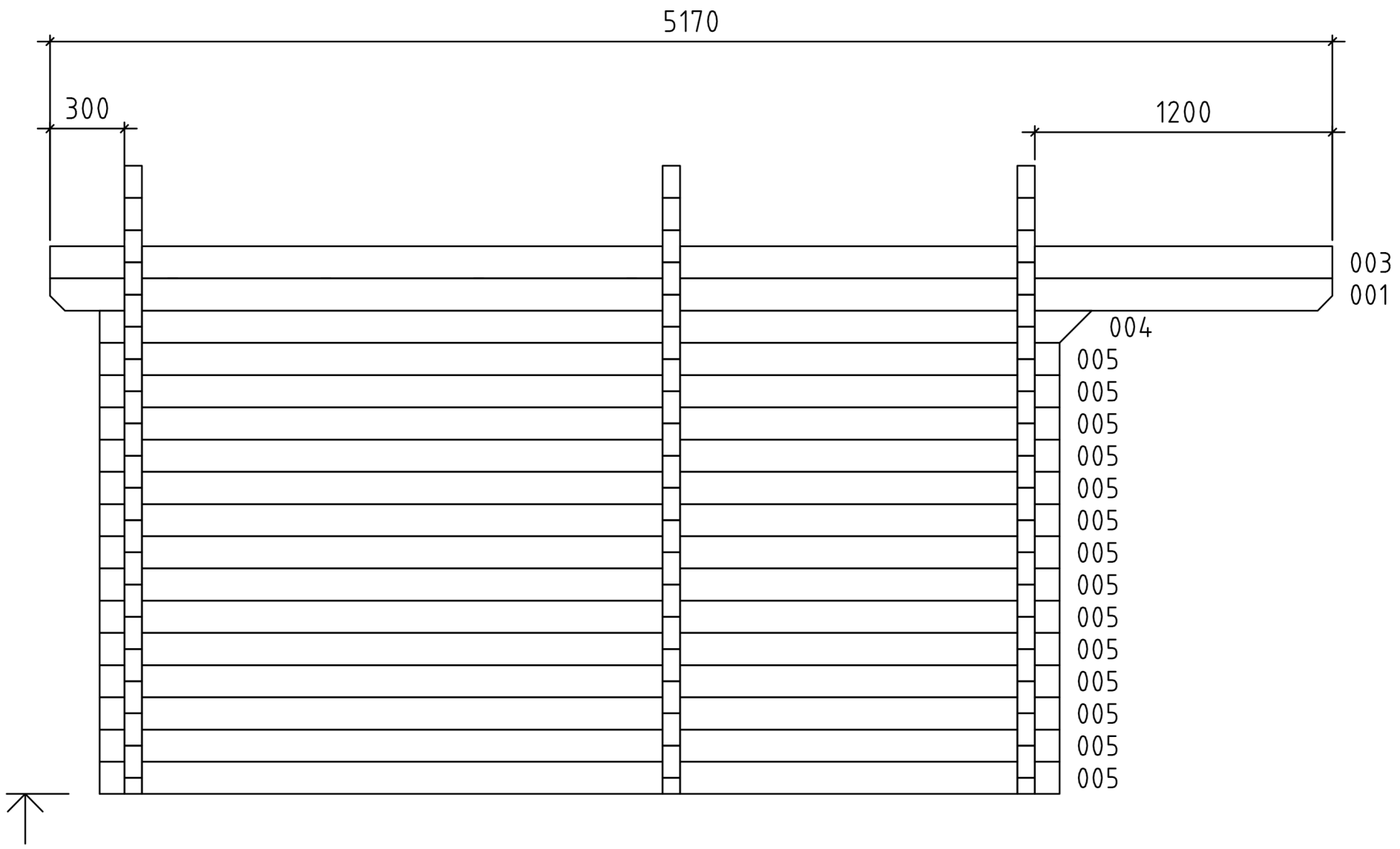



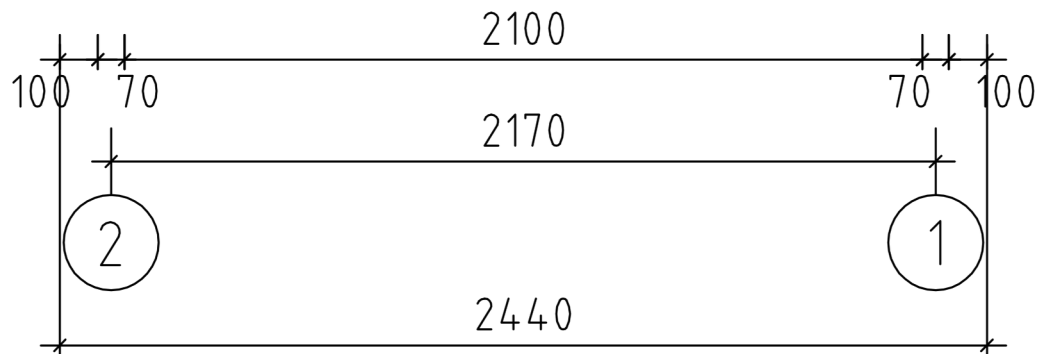
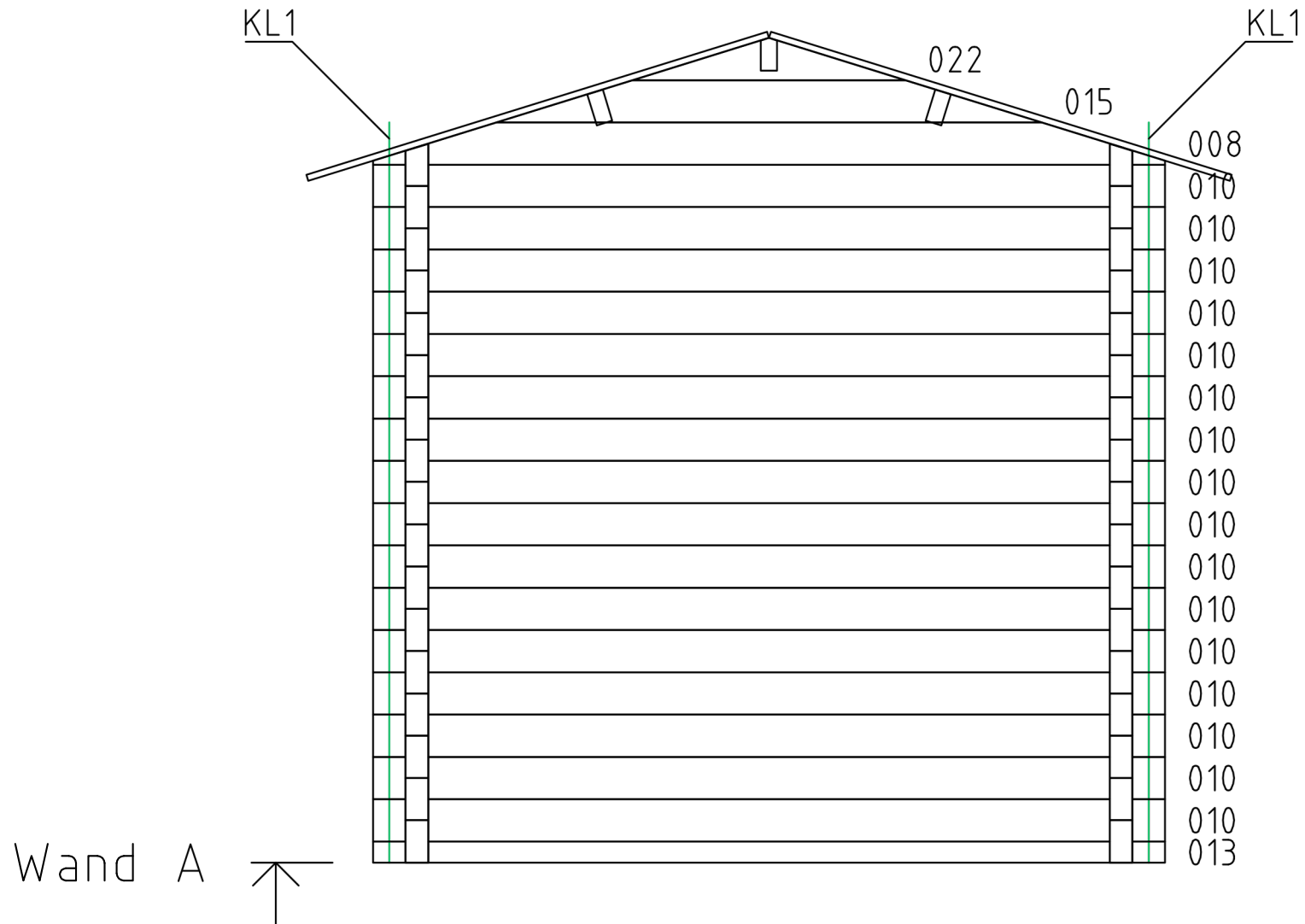

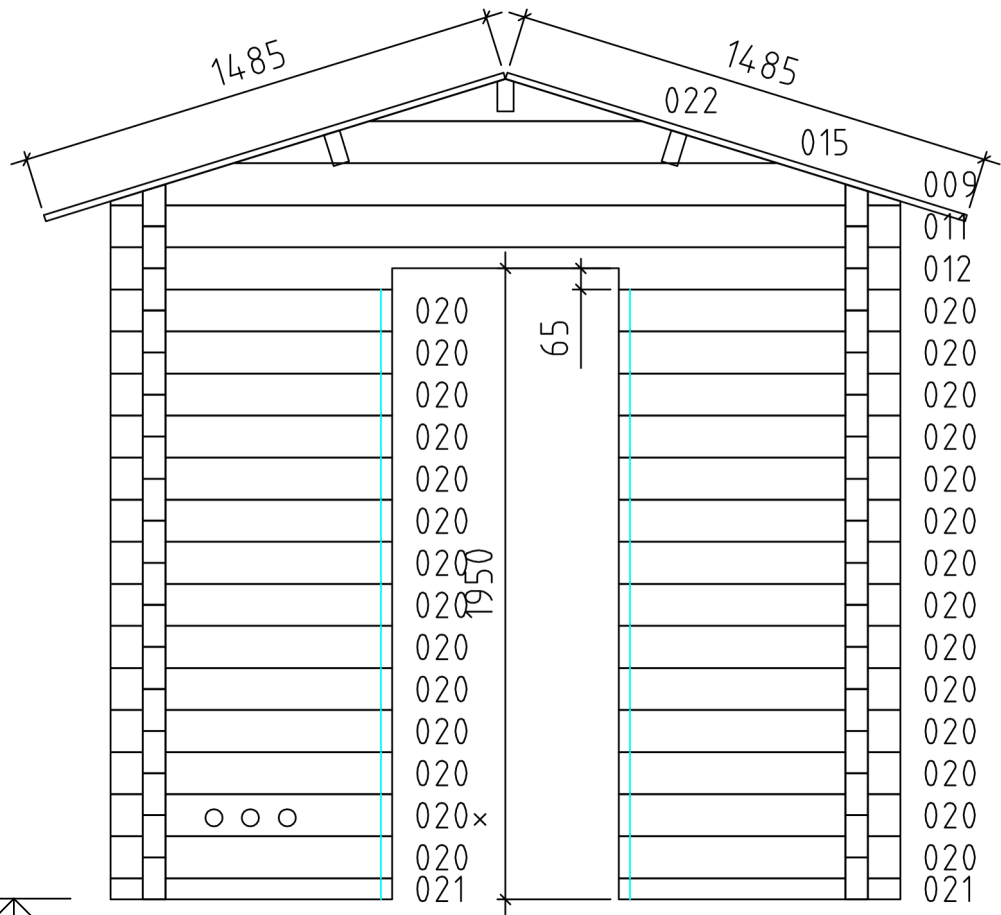

Wand B

