

Wand 3 ↑

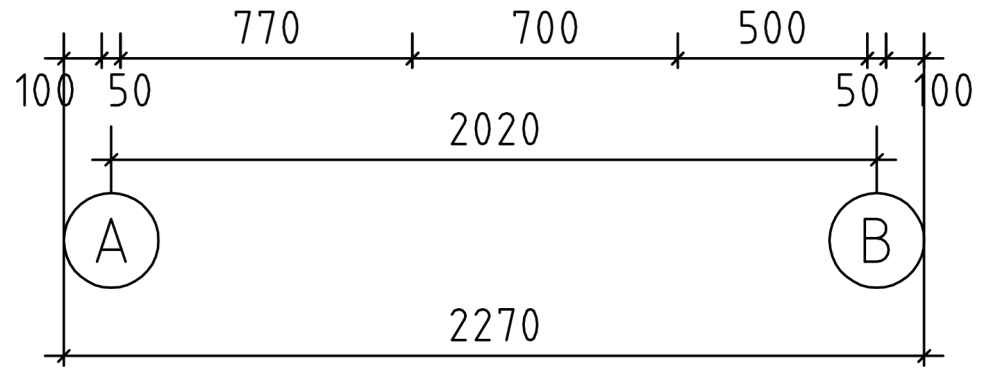

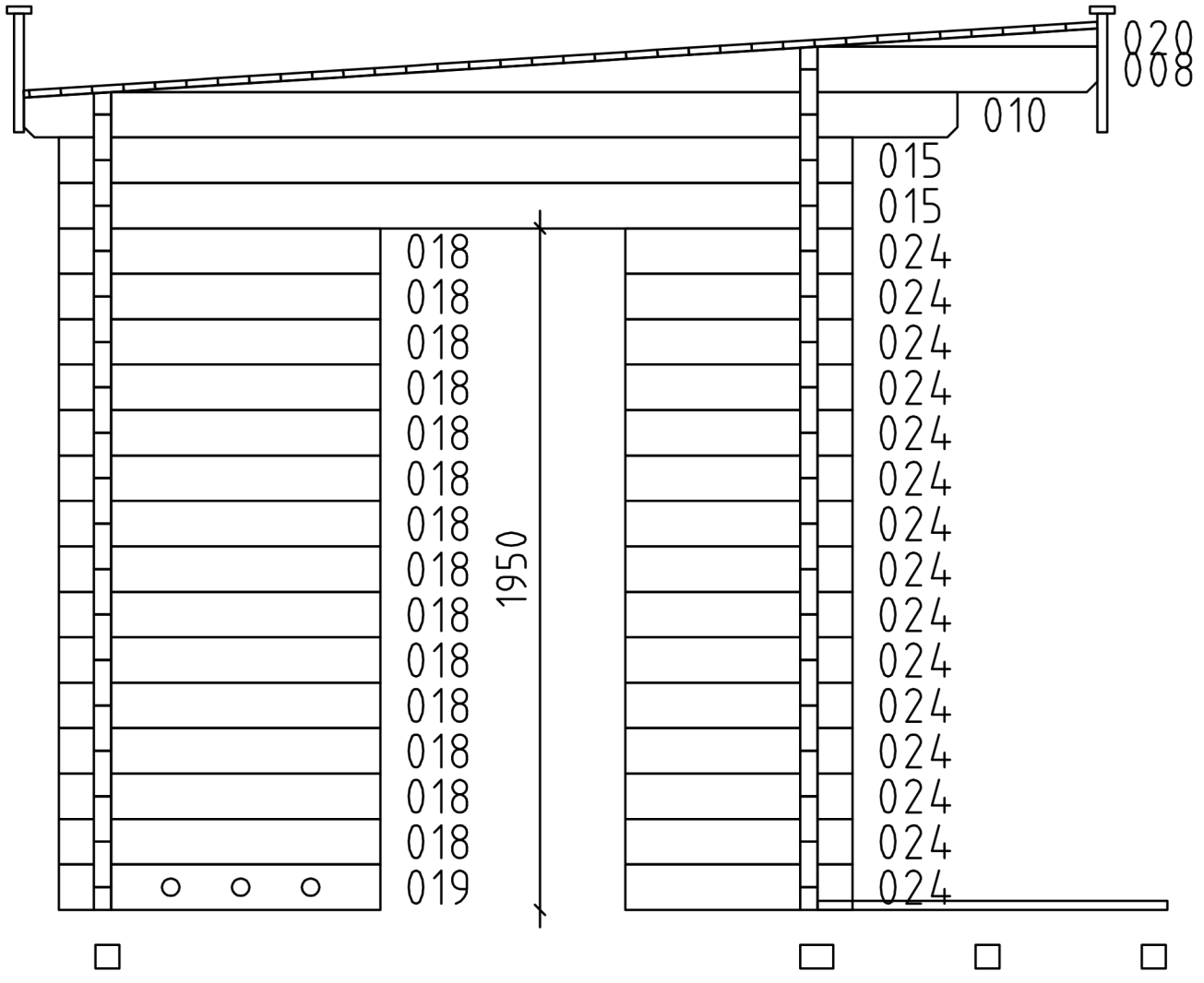

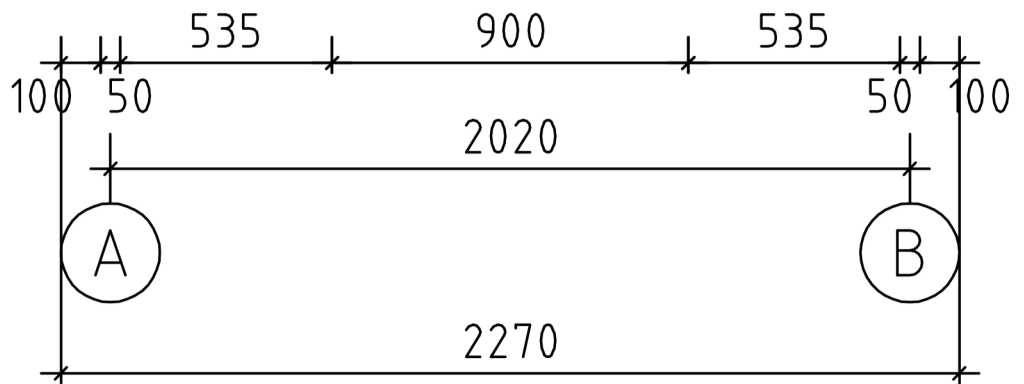

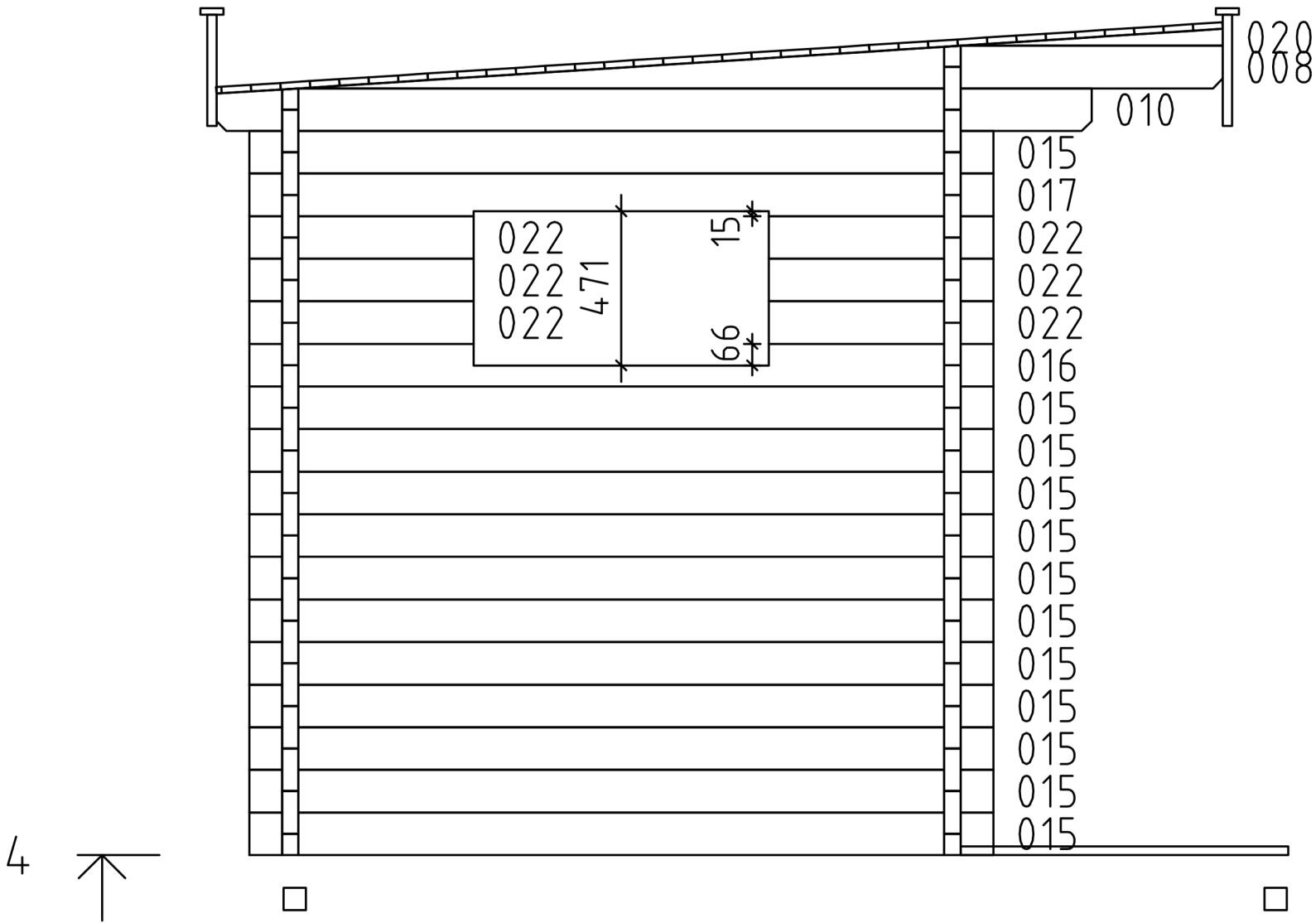
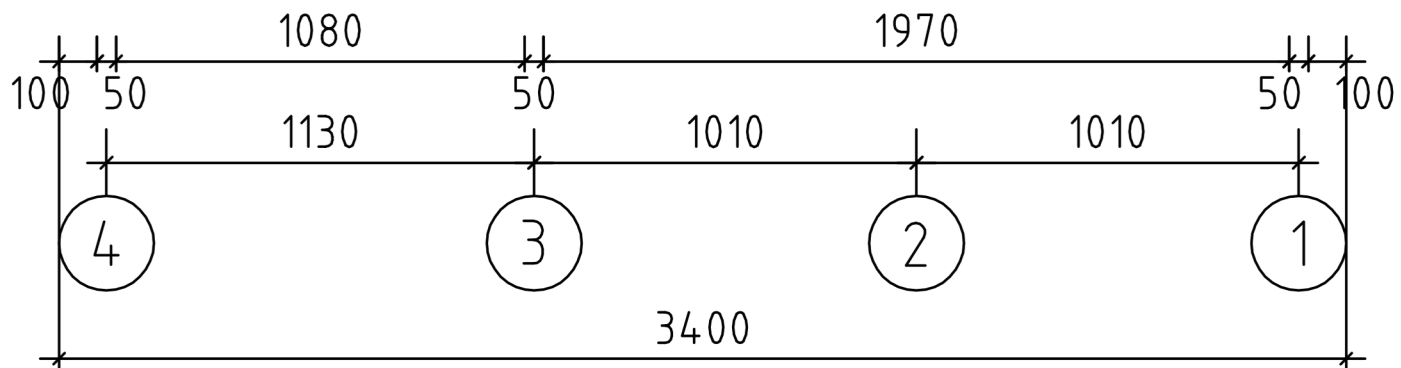
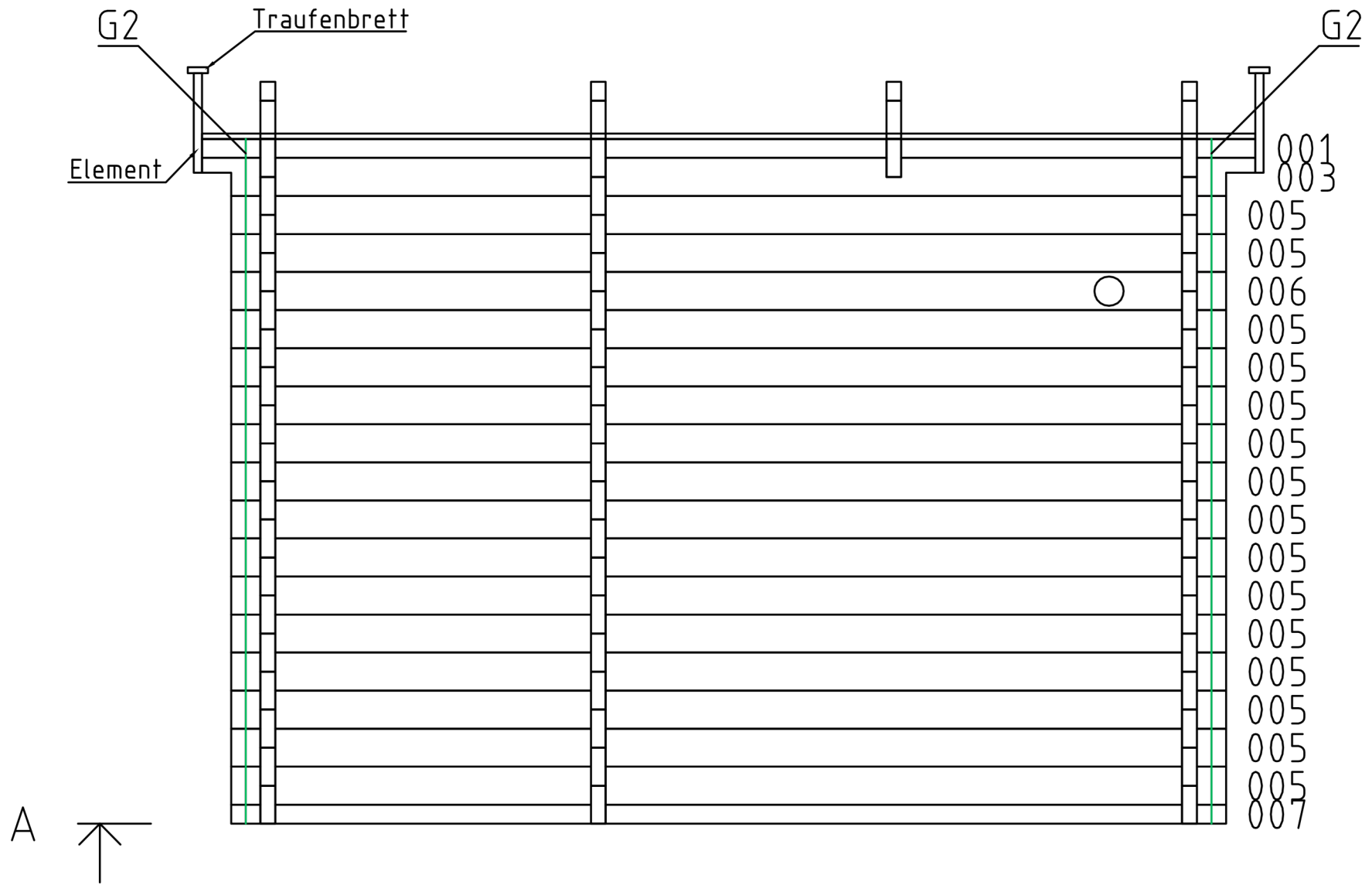
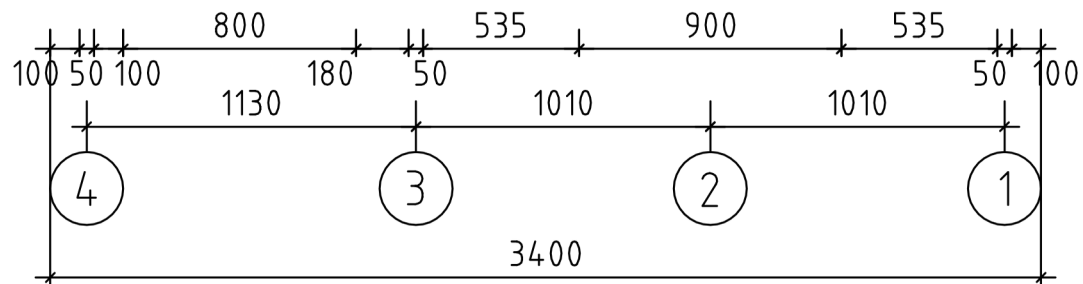
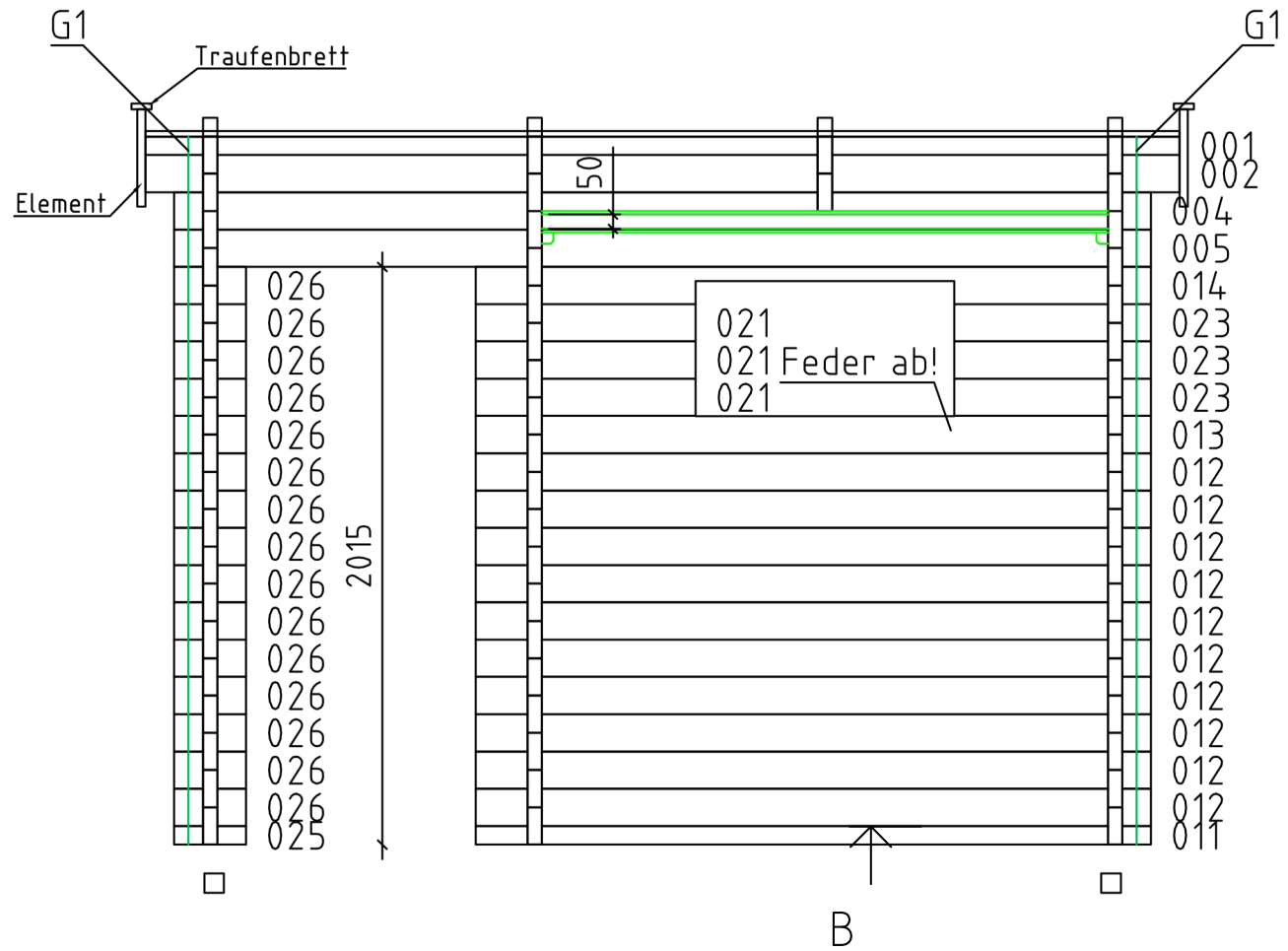

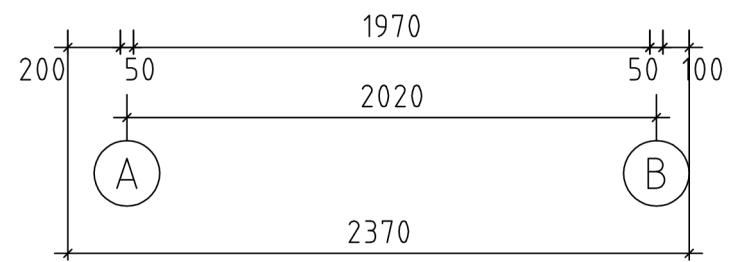
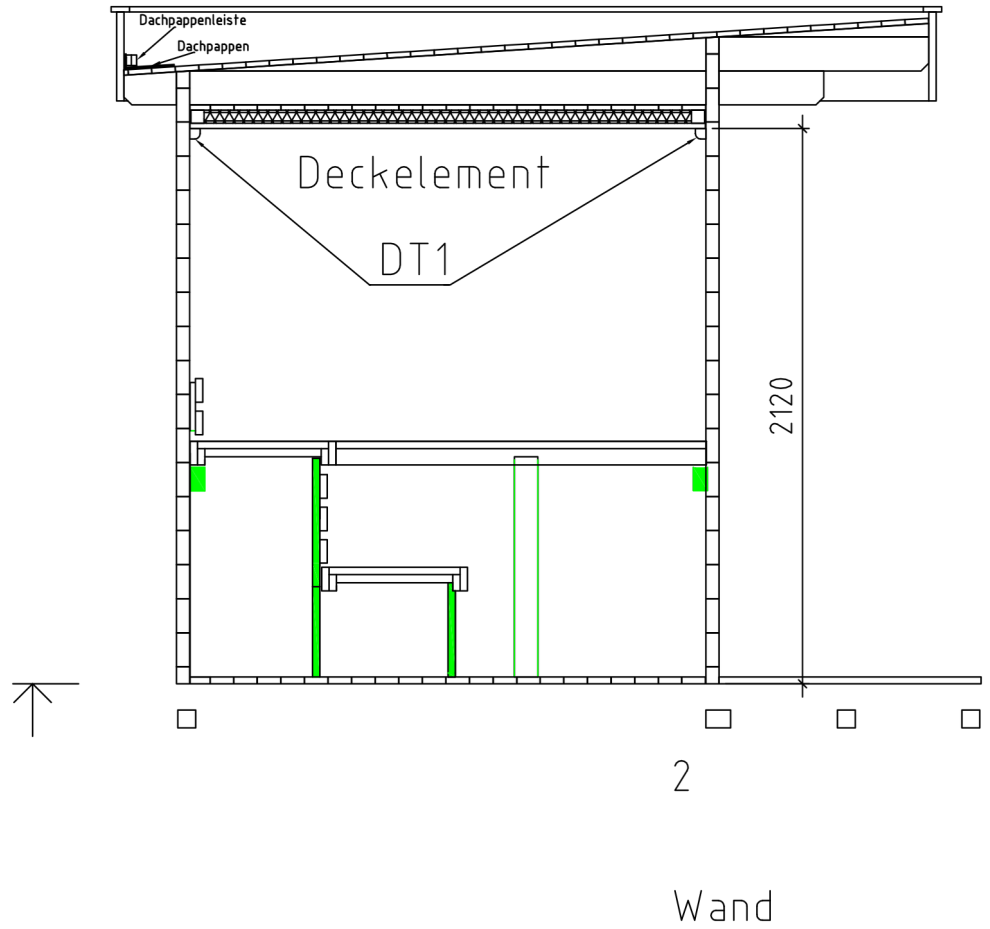

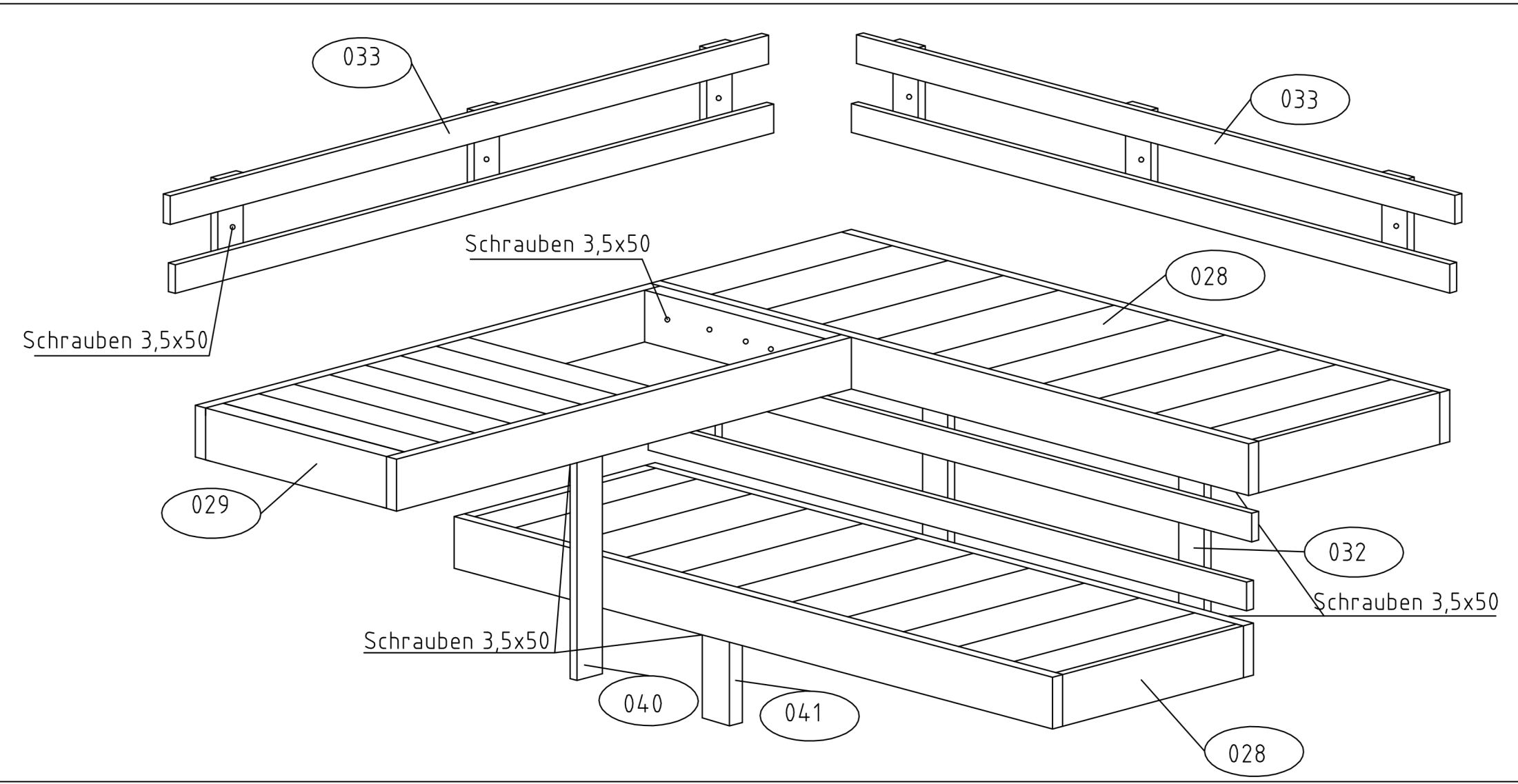





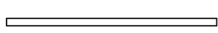

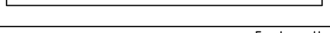



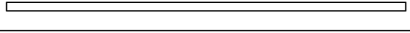





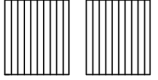
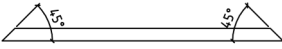



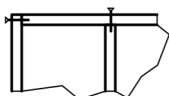





Pos		ST	F (mm)	L (mm)
001		2	50x65	3600
002		1	50x130	3600
003		1	50x130	3600
004		1	50x130	3400
005		16	50x130	3400
006		1	50x130	3400
007		1	50x65	3400
008		3	50x130	2820
009		1	50x130	2820
010		4	50x130	2670
011		1	50x65	2350
012		10	50x130	2350
013		1	50x130	2350
014		1	50x130	2350
015		31	50x130	2270
016		1	50x130	2270
017		1	50x130	2270
018		14	50x130	920
019		1	50x130	920
020		4	50x51	800
021		3	50x130	765
022		6	50x130	685
023		3	50x130	685
024		15	50x130	650
025		1	50x65	250

Pos		ST	F (mm)	L (mm)
026		15	50x130	250
AR2	 Fundamentbalken	Impr. 1	94x68	3054
AR6	 Fundamentbalken	Impr. 1	94x68	1947
AR1	 Fundamentbalken	Impr. 2	68x68	3190
AR3	 Fundamentbalken	Impr. 1	68x68	3054
AR4	 Fundamentbalken	Impr. 2	68x68	2924
AR5	 Fundamentbalken	Impr. 3	68x68	1947
TR1	 Element	2	28x340	3656
TR2	 Element	2	28x340	3090
VL1	 Traufenbrett	2	20x70	3698
VL2	 Traufenbrett	2	20x70	3168
0203	Dichtungsband			8m
0203	Fussbodenbretter 	22	90x26	1966
0203	Fussbodenbretter 	22	90x26	1076
	Abdeckleiste 		20x40	29m
	Dachbretter 	35	90x20	3600
	Terrassenbretter  Impr.	34	90x26	1000
	Dachpappenleiste		20x40	28m
	Deckelement (Zwischendeck) 	1+1		
DT1	Trägleiste für Deckelemente Befestigung 	4	35x35	1970
G1	Gewindestift 12 	2		2550
G2	Gewindestift 12	2		2400
Kood	Materjal	File	trükk.dwg	Leht 2/3

Pos		ST	F (mm)	L (mm)
028	Liegen	2		1968
029	Aspen	1		1412
037	Träger für Liegen	2	44x68	1100
038		1	44x68	700
039		2	44x68	576
040	Liegenstütze	1	44x68	841
041		1	44x68	360
032	Zwischenbankverkleidung Aspen	1		
033	Rückenlehnen Aspen	1+1		
034	Ofenschutzgitters	1		
035	Kopfstütze Aspen	2		
046	Schrauben für Liegenträger	50	4,5x70	
047	Schrauben für Liegen	50	3,5x50	
048	Schrauben für Ofenschutzgitters	20	4x80	
048	Schrauben für Elemente	50	4,5x70	
Fundament	  Schrauben 6x130 	20		
Fussboden	 Schrauben 3,5x50 	350		
Dach	 Schrauben 4,2x55 (Terrassenschrauben) 	120		
Montage	Giebel  Schrauben 6x130 	30		
	Elemente + Wand  Schrauben 5x80 	40		
Kood	Materjal	File	frükk.dwg	Leht 1/1

