



control solutions

**TERACOM**



## TCG120-4 4G LTE wireless I/O module

## USER MANUAL

## 1. Short description

TCG120-4 is a 4G LTE Cat.1 wireless I/O module. It supports also 2G wireless communication and provides data connectivity on LTE-FDD, EDGE and GPRS networks.

The device has 2 digital inputs, 2 analog inputs, 1-Wire interface for external sensors and 2 relays. The relays can be activated either remotely (via SMS or HTTP API command) or locally - from the status of the monitored parameters.

TCG120-4 supports all 1-Wire sensors of Teracom.

The universal I/O module supports HTTP API for easy M2M communication. The device sends periodically an HTTP/HTTPS Post to a remote server with an XML/JSON status file. As an answer, the server can send commands for relay activation or settings change.

## 2. Features

- Multi-band connectivity;
- Setup via USB, SMS, and HTTP API;
- 2 digital "dry contact" inputs;
- 2 analog inputs with 0 to 60VDC range;
- 2 relays with NO and NC contacts;
- 1-Wire support for all Teracom sensors;
- MQTT 3.1.1 support;
- SMS alarm alerts for up to 5 numbers;
- Email alarm alerts for up to 5 email recipients;
- Periodical HTTP/HTTPS Post with current status in XML or JSON file to a remote server;
- HTTP API commands;
- GSM geolocation;
- Firmware update over USB or Internet.

## 3. Applications

TCG120-4 is suitable for industrial automation, data acquisition systems, environmental monitoring, local control of an electrical and non-electrical parameter, building automation, etc.:

- SCADA systems  
TCG120-4 be easily integrated into SCADA systems. The periodical HTTP/HTTPS Post is suitable for client-server platforms.
- Environmental monitoring and control

## 4. Specifications

- Physical characteristics  
Dimensions: 109 x 65 x 32 mm  
Weight: 152 g  
Mounting: wall
- Environmental limits  
Operating temperature: -20 to 55°C  
Operating temperature for USB setup: 0 to 40°C  
Storage temperature: -25 to 60°C  
Ambient Relative Humidity: 5 to 85% (non-condensing)

- Standards and Certifications

Safety: EN 62368-1:2014 + EN 62368-1:2014/AC1-3:2015 + EN 62368-1:2014/A11:2017 + EN 62368-1:2014/AC:2017-03:2017, EN 62311:2008

EMC: EN 55032: 2015 + EN 55032: 2015/AC:2016-07 + EN 55032: 2015/A11:2020  
EN 55024: 2010 + EN 55024: 2010/A1:2015

EN 61000-3-2: 2014  
EN 61000-3-3: 2013 + EN 61000-3-3: 2013/A1:2019

RFU: EN 301 489-19 V2.1.1, EN 301511 V12.5.1, EN 301 908-1 V11.1.1,  
EN 301 908-13 V11.1.2, EN 301 908-2 V11.1.2, EN 303 413 V1.1.1

Green: RoHS

- Warranty

Warranty period: 3 years

- Power supply

Operating voltage range (including -15/+20% according to IEC 62368-1): 10 to 28 VDC

Current consumption: 0.24A @ 12VDC

- Cellular interface

Standards: LTE-FDD, EDGE and GPRS

TCG120-4E (h2.xx) bands:

4G LTE: B1/B3/B5/B7/B8/B20

2G: B3/B8

TCG120-4G (h2.xx) bands:

4G LTE: B1/B2/B3/B4/B5/B7/B8/B12/B13/B18/B19/B20/B25/B26/B28/  
B66/B34/B38/B39/B40/B41

3G: B1/B2/B4/B5/B6/B8/B19

2G: B2/B3/B5/B8



**Attention!**

The device can be used only in networks that support IPV4 addresses (IPV6 is not supported).  
Ask your SIM card provider to confirm this.

SIM card size: Standard

Antenna connector: SMA-F

- Analog inputs

Isolation: Non-isolated

Type: Single-ended

Resolution: 10 bits

Input Range: 0 to 60 VDC

Accuracy: ±1%

Sampling Rate: 500ms per channel (averaged value of 250 samples)

Input Impedance: 1 mega-ohm (min.)

- Digital inputs

Isolation: Non-isolated

Type: Dry contact and logic level

Minimum high-level input voltage for digital inputs: +2.5VDC

Maximum low-level input voltage for digital inputs: +0.8VDC

Maximum input voltage for digital inputs: +5.5VDC

Sampling rate: 10ms

Digital filtering time period: 30ms

- Relay outputs

Type: Form C (N.O. and N.C. contacts)

Contact current rating: 3 A @ 24 VDC, 30 VAC (resistive load)

Initial insulation resistance: 100 mega-ohms (min.) @ 500 VDC

Mechanical endurance: 10 000 000 operations

Electrical endurance: 100 000 operations @ 3 A resistive load

Contact resistance: 50 milli-ohms max. (initial value)

Minimum pulse output: 0.1 Hz at rated load

CAUTION: The device does not contain any internal overcurrent protection facilities on the relays' contact lines.

External fuses or short circuit current limiting circuit breakers, rated to 3 Amps, are to be used for overcurrent protection of the connecting lines.

- 1-Wire interface

Output voltage:  $5.0 \pm 0.3$  VDC

Maximum output current: 200 mA

- Internal FLASH memory

- Endurance: 100 000 cycles (Every relay status and settings change is a memory cycle)

## 5. Installation

This device must be installed by qualified personnel. The installation consists of mounting the device, connecting the antenna, connecting inputs and outputs, providing power, and configuring via a web browser. This device must not be installed directly outdoors.

**Attention!** Before installing the SIM card in the card slot, please ensure that the PIN code is disabled.

### 5.1. Mounting

TCG120-4 should be mounted in a clean and dry location on a non-flammable surface. Ventilation is recommended for installations where the ambient air temperature is expected to be high.

Mount the device to a wall by using two plastic dowels 8x60mm (example Würth GmbH 0912 802 002) and two dowel screws 6x70mm (example Würth GmbH 0157 06 70). See Appendix D, fig. 1 for mechanical details.

Maintain spacing from adjacent equipment. Allow 50 mm of space on all sides, as shown in fig.2 in Appendix D, this provides ventilation and electrical isolation.

### 5.2. Connectors

**Attention!** Disconnect the power supply before wiring.

The correct wiring procedure is as follows:

- Make sure power is turned off;
- Make wiring connections to the terminals;
- Apply power.

It is recommended to test and configure TCG120-4 without any controlled device.

Make sure that wires are properly attached to the terminals and that the terminals are tightened. Not proper wiring and configuration can cause permanent damage to the module or the equipment to which it is connected or both.

Inputs and outputs locations are shown below:

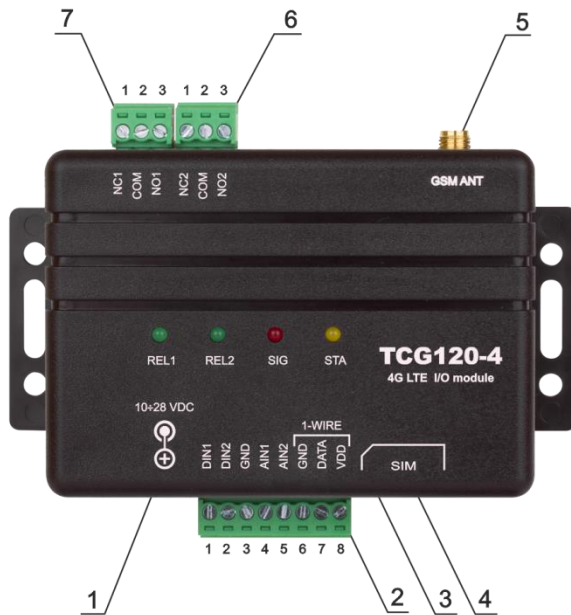

- Connector 1** – Power - 2.1x5.5mm connector, central positive
- Connector 2, Pin1** - Digital input 1 (**Din1**)\*
- Connector 2, Pin2** - Digital input 2 (**Din2**)\*
- Connector 2, Pin3** - Ground
- Connector 2, Pin4** - Analog input 1 (**Ain1**)
- Connector 2, Pin5** - Analog input 2 (**Ain2**)
- Connector 2, Pin6** - Ground
- Connector 2, Pin7** – 1-Wire data
- Connector 2, Pin8** – 1-Wire power supply
- Connector 3** – mini USB
- Connector 4** – SIM card holder
- Connector 5** – GSM Antenna
- Connector 6, Pin1** – NC Relay2
- Connector 6, Pin2** – COM Relay2
- Connector 6, Pin3** – NO Relay2
- Connector 7, Pin1** – NC Relay1
- Connector 7, Pin2** – COM Relay1
- Connector 7, Pin3** – NO Relay1

### 5.2.1. Power supply connection

TCG120-4 is designed to be supplied by adapter SYS1308N-2412-W2E or similar, intended for use in the conditions of overvoltage category II. The power supply equipment shall be resistant to short circuits and overload in a secondary circuit.

When in use, do not position the equipment so that it is difficult to disconnect the device from the power supply.

### 5.2.2. 1-Wire interface

1-Wire is a registered trademark of Maxim integrated products, Inc. It is designed to connect several sensors over short wiring. It is not suitable for long distances or noisy environments.

The maximum number of 1-Wire sensors connected to TCG120-4 is four.

The device supports all Teracom 1-Wire sensors. Connected sensors are automatically detected and the appropriate dimension is assigned.

It is strongly recommended to use “daisy-chained” (linear topology) for multi-sensor systems:

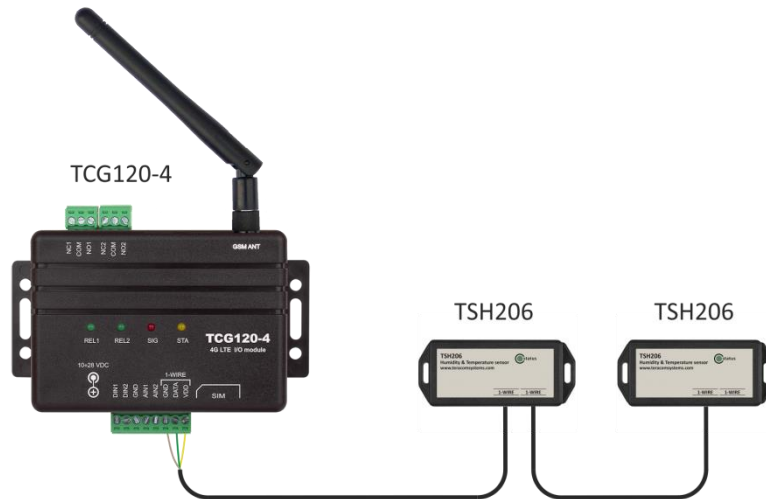

“Star” topology can be used only as a last resort for up to 4 sensors and total cable length up to 10 meters:

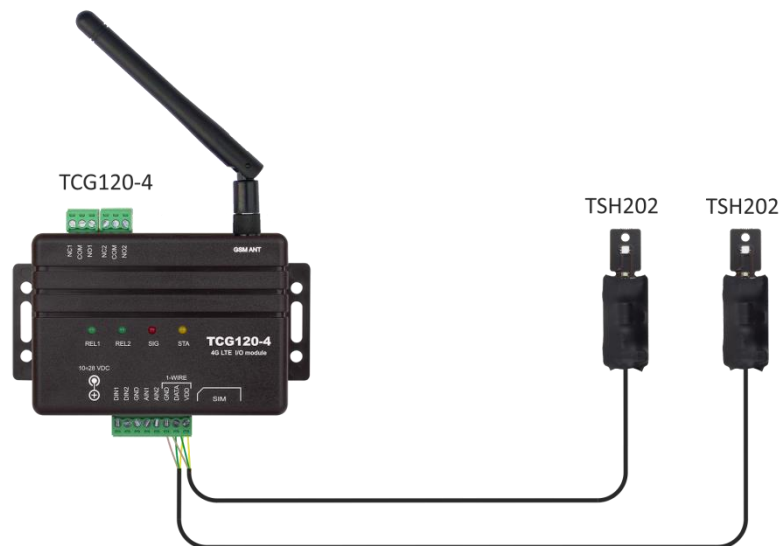

It is strongly recommended to use only UTP/FTP cables and keep the total cable length up to 30m. Although functionality has been achieved in the longer distance, we cannot guarantee error-free operation over mentioned wiring length. We recommend reading Maxim’s 1-Wire tips at <https://www.teracomsystems.com/wp-content/uploads/1-wire/guidelines-for-reliable-long-line-1-wire-networks.pdf>.

We guarantee proper operation only with Teracom 1-Wire sensors.

### 5.2.3. Digital inputs connection

**Attention!** Digital inputs are NOT galvanic isolated.

The TCG120-4 digital inputs can be used as “dry contact” only.

The term “dry contact” means that to this input can be connected devices with an open drain or relay outputs - door contact switch, push-button, PIR detector, etc.



The following picture illustrates how an alarm button can be connected to a digital input of TCG120-4. One side of the contact is connected to “Digital In” while the other side is connected to the “GND” terminal.



The maximum cable length for a digital input should be up to 30 meters.

#### 5.2.4. Analog inputs connection

**Attention!** Analog inputs are NOT galvanic isolated.

Analog inputs of TCG120-4 can be used for monitoring DC voltage up to 60VDC. They can be connected directly to batteries, solar panels, power supplies etc.

The “Multiplier”, “Offset” and “Dimension” for every analog input gives a possibility to monitor sensors with analog outputs and see directly the measured parameter.

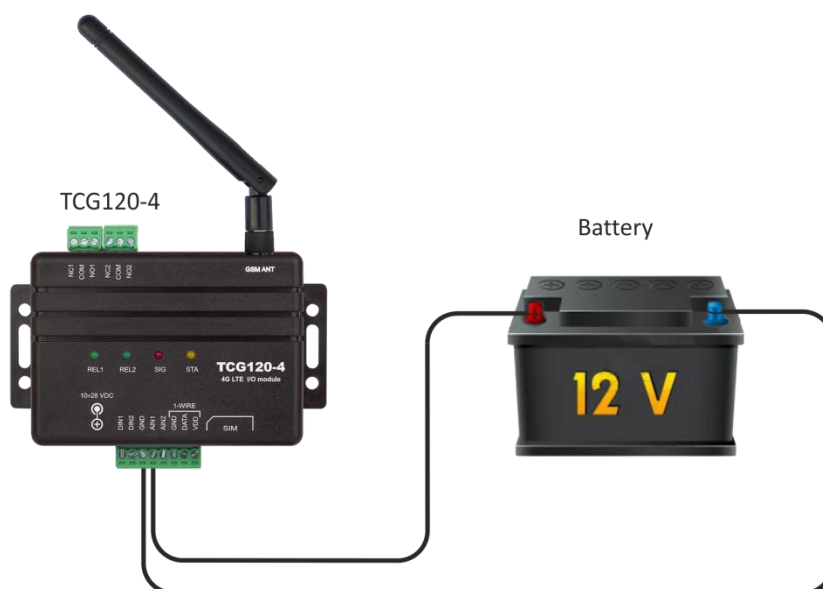

#### 5.2.5. Relays connection

The relay contacts are internally connected directly to the terminal connectors.

**Attention!** There isn't any internal overcurrent protection on the relays' contact lines.

For all relays normally open, normally closed and common contacts are available. For loads with higher switchable current/voltage than specified, an external relay should be used.

When mechanical relays switch inductive loads such as motors, transformers, relays, etc., the current will arc across the relay contacts each time the contacts open. Over time, this cause wears on the relay contacts which shorten their life. When switching an inductive load, it is recommended that relay contact protection devices are used.

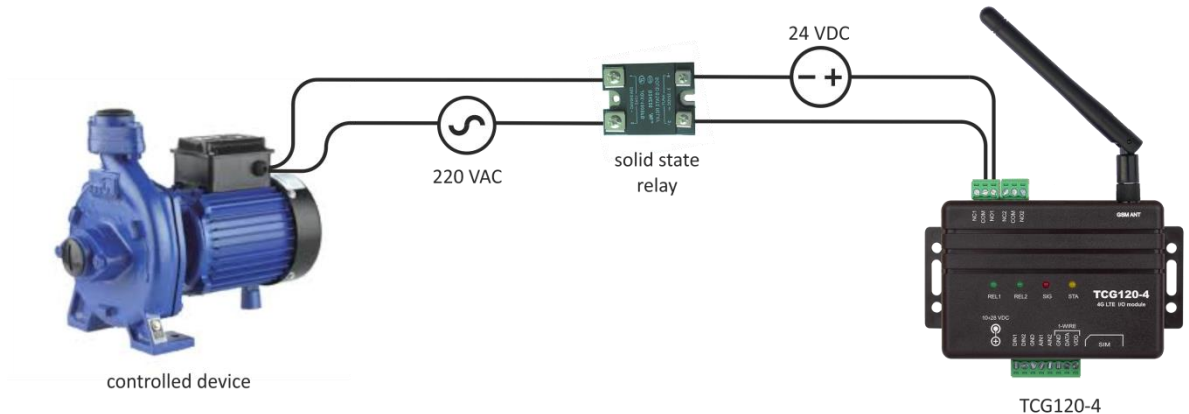

## 6. LED indicators

LED indicators show the status of the module:

- **REL1 – REL2** (green) – the LED is ON when the corresponding relay is activated (the NO contact is connected to COM);
- **SIG** (red) – indicates the status of the device together with STA
- **STA** (yellow) – indicates the status of the device together with SIG.

The following states are displayed:

- **Module initialization** – after power-on SIG and STA turn ON for a second, after this turn OFF for another second.

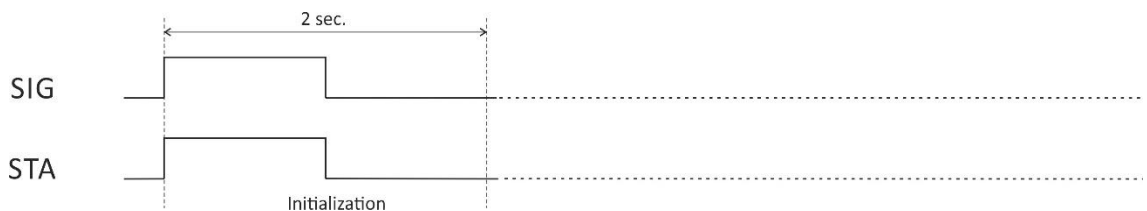

- **Searching for a network** – after initialization, SIG is OFF, STA flashes (flash period of 200ms)

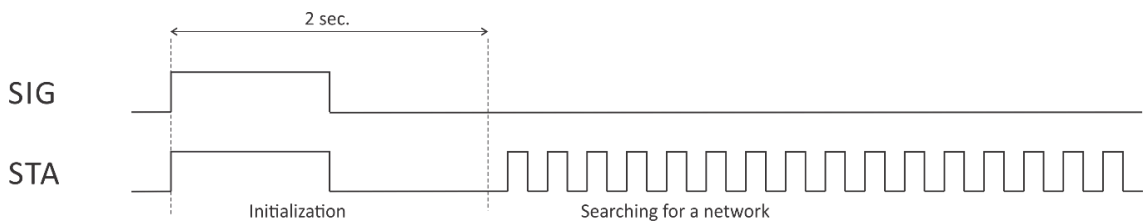

- **Connected to a network** – after a successful connection to a mobile network, STA shows the type of connection, while SIG shows the signal strength.

STA flashes ones for 200ms in a period of 2s – there is GSM connection only;

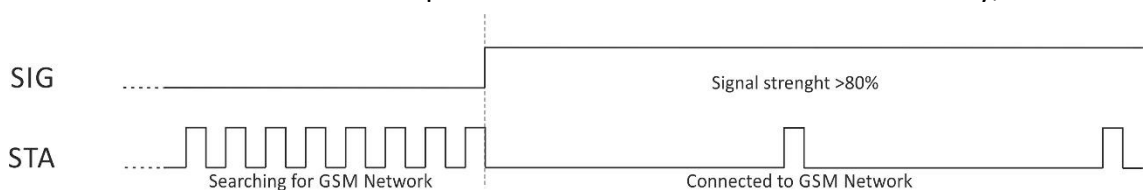

STA flashes twice for 200mS in a period of 2s – there are GSM and 4G/3G/2G connections.



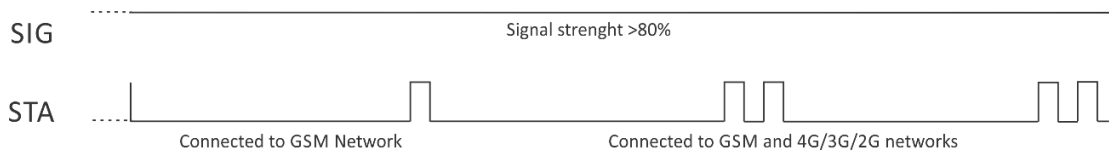

At the same time SIG has 5 states:

- SIG flashes 1 time in a period of 2s – signal strength is between 0 and 20%;
- SIG flashes 2 times in a period of 2s – signal strength is between 21 and 40%;
- SIG flashes 3 times in a period of 2s – signal strength is between 41 and 60 %;
- SIG flashes 4 times in a period of 2s – signal strength is between 61 and 80%;
- SIG is solid ON – signal strength is between 81 and 100%;

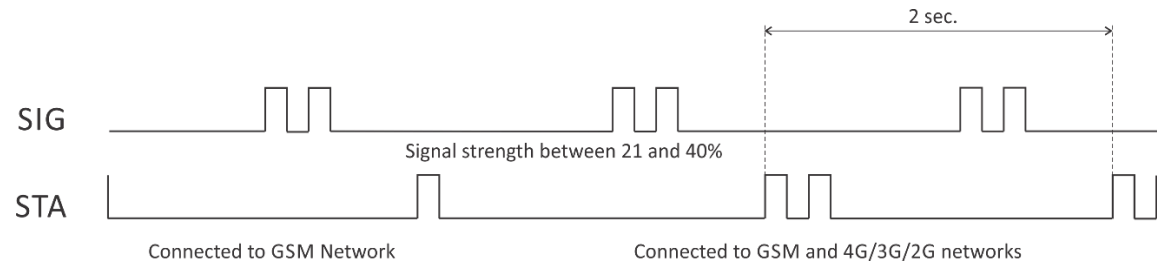
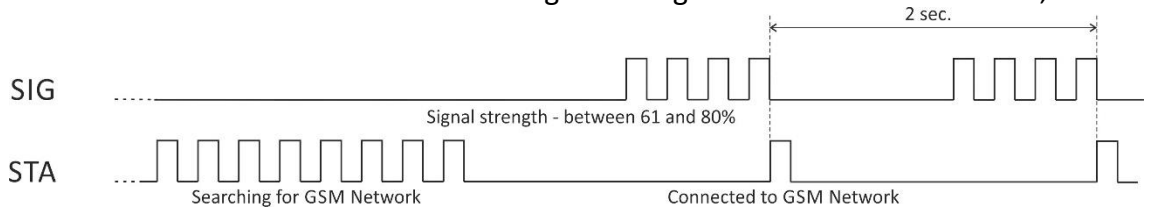

- **Error message** – in case of error after initialization, SIG will stay solid OFF, STA will flash showing the type of error.

- STA flashes ones for 1s – master phone number is not set;
- STA flashes permanently for 1s in a period of 2s – permanent hardware error.

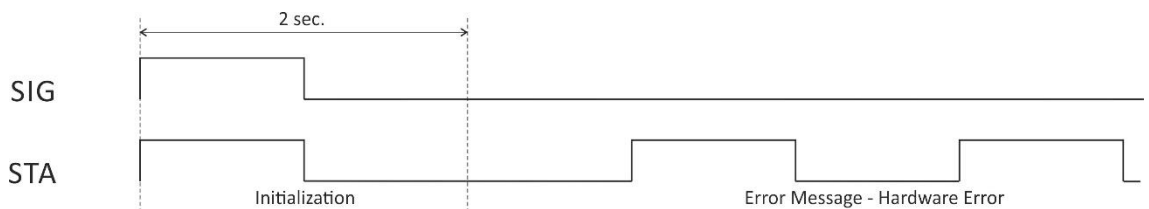
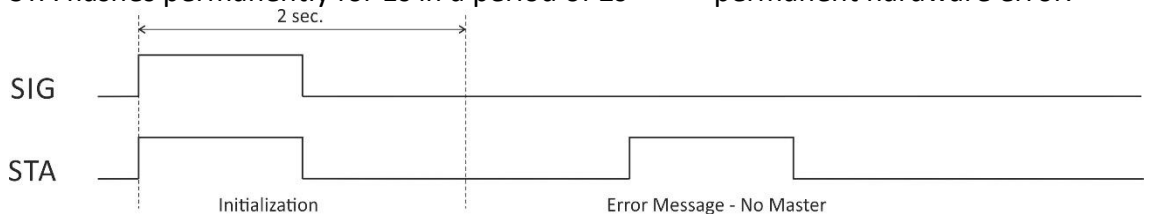

## 7. Initial setup via USB

The initial setup of TCG120-4 is done with a computer running Windows 7 or a newer Microsoft Windows operating system. After power-up, the module should be connected to the computer with a USB cable. Once the USB cable is connected, the operating system automatically starts to install the drivers for the communication with the device. The following message appears:

**Setting up a device**  
We're setting up 'Microchip Composite Device'.

The following drivers will be installed:

- Microchip composite device
- USB serial port driver

**Device is ready**  
'Microchip Composite Device' is set up and ready to go.

If for some reason the USB serial port driver cannot be installed automatically, it must be installed manually.

The driver can be downloaded from the TCG120-4 product page at [www.teracomsystems.com](http://www.teracomsystems.com). After successful driver installation, the device will be recognized as Mass storage, the following window appears on the screen:

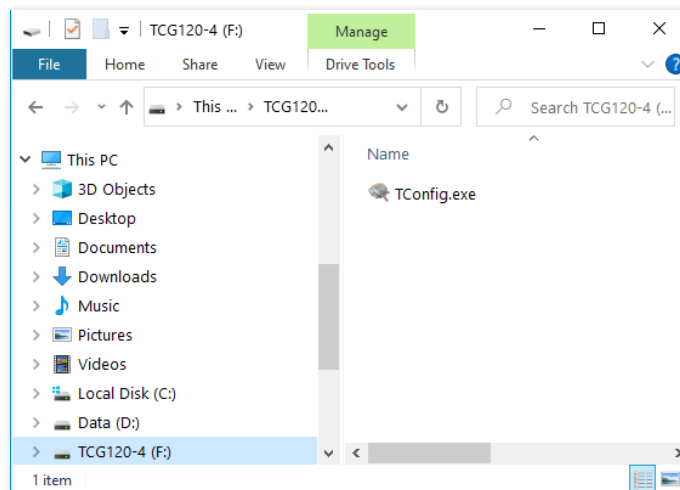

The only file stored on the mass storage is a tool called “TConfig”. This tool enables communication between the TCG120-4 and PC. After starting the TConfig tool, the following program will appear:

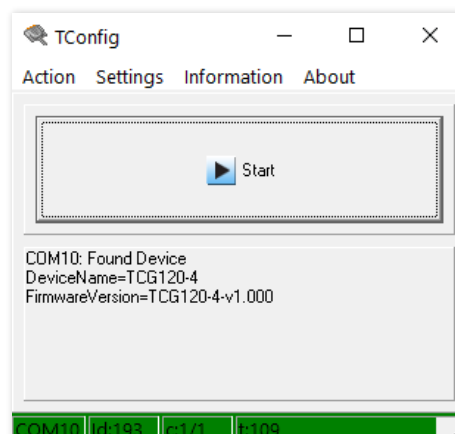

Pressing the “Start” button will start the browser and display the Monitoring page of your TCG120-4.

## 7.1. Monitoring page

The monitoring page displays the current inputs/outputs status of TCG120-4. The page has 4 sections – “1-Wire sensors”, “Analog inputs”, “Digital inputs” and “Relays”.

For every parameter (sensor, input, relay) there is a description of up to 15 characters. The descriptions can be changed on the “Setup-Input/Output” page.

### 7.1.1. Sensors section

| 1-Wire sensors |             |         |         |                  |
|----------------|-------------|---------|---------|------------------|
| Pos            | Description | Value 1 | Value 2 | ID               |
| 1              | S1:TSH230   | 24.7°C  | 45.4%RH | 010140C6E8FFCE65 |
| 2              | S2          | .....   | .....   | 0000000000000000 |
| 3              | S3          | .....   | .....   | 0000000000000000 |
| 4              | S4          | .....   | .....   | 0000000000000000 |

TCG120-4 supports up to four sensors.

All detected 1-Wire sensors are shown in the “1-Wire sensors” section. The sensors should be set up in section “1-Wire sensors setup” on the Setup->Sensors page.

For every sensor, there is a description, value, and ID information. The description length is up to 15 characters. The descriptions can be changed on the Setup->Conditions page.

Teracom temperature sensors readings are shown in the Value 1 column. TSH2xx temperature-humidity sensors have the 2nd parameter shown on the Value 2 column.

### 7.1.2. Digital inputs section

| Digital inputs  |        |                 |        |
|-----------------|--------|-----------------|--------|
| Digital input   | Status | Digital input   | Status |
| Digital Input 1 | OPEN   | Digital Input 2 | OPEN   |

Digital inputs can be used for monitoring the state of discrete devices – motion sensor, door contact, relay contact, alarm output, etc.

Digital inputs are sampled every 10ms. The change of input status is considered valid if the same value is read in 3 consecutive samples (30ms).

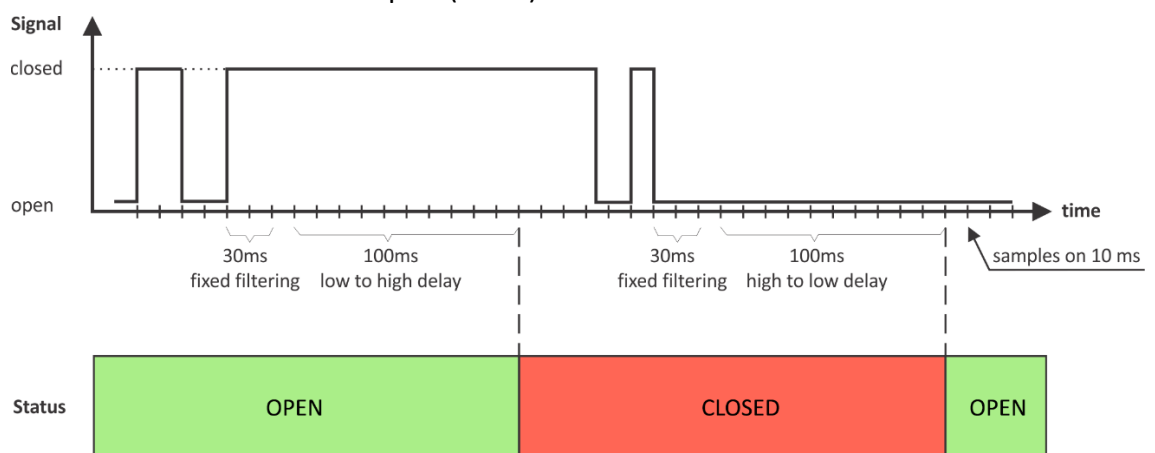

The status of every input is shown by text and by color.

The descriptions and status texts can be changed in “Setup-Input/Output”.

### 7.1.3. Analog inputs section

| Analog inputs  |        |                |        |
|----------------|--------|----------------|--------|
| Analog input   | Value  | Analog input   | Value  |
| Analog Input 1 | 0.000V | Analog Input 2 | 0.000V |

Analog inputs can be used for monitoring DC voltage sources – analog sensors, batteries, power supplies, solar panels, etc.

Analog inputs are sampled faster, but the new actual value is changed in 0.5 seconds. All 250 readings between the value changes are averaged.

For every analog input “Unit”, “Multiplier” and “Offset” can be set in the “Setup-> Input/Output” section.

### 7.1.4. Relay section

| Relays  |        |         |                   |
|---------|--------|---------|-------------------|
| Relay   | Status | Control |                   |
| Relay 1 | OFF    | ON      | OFF Pulse         |
| Relay 2 | OFF    | ON      | OFF Pulse         |
|         |        | All On  | All Off Pulse All |

The section displays the current state of relays. Each relay can be activated either remotely or locally from the status of a monitored parameter. For locally activated relays a text describing the controlling parameter is displayed rather than buttons.

Pulse duration and parameters for local relay activation can be set separately for each relay in “Setup->Input/Output->Relay outputs”.

## 7.2. Setup

### 7.2.1. SMS

SMS Setup

|  |   |   |
|--|---|---|
| <p>Number format ⓘ</p> <p>Master: [+][Country code][Network prefix][Number] <input type="text" value="+359885711114"/></p>   | <p>Connectivity alert ⓘ <input checked="" type="checkbox"/></p>   | <p>Alarm notification <input checked="" type="checkbox"/></p>   |
| <p>Number format ⓘ</p> <p>User 1: [+][Country code][Network prefix][Number] <input type="text"/></p> <p>User 2: [+][Country code][Network prefix][Number] <input type="text"/></p> <p>User 3: [+][Country code][Network prefix][Number] <input type="text"/></p> <p>User 4: [+][Country code][Network prefix][Number] <input type="text"/></p> <p><input type="button" value="send test SMS"/></p> | <p>Superuser rights ⓘ</p> <p><input type="checkbox"/></p> <p><input type="checkbox"/></p> <p><input type="checkbox"/></p> <p><input type="checkbox"/></p> | <p>Alarm notification</p> <p><input type="checkbox"/></p> <p><input type="checkbox"/></p> <p><input type="checkbox"/></p> <p><input type="checkbox"/></p> |

SMS alarm recipients can be set in this section.

The “Master” has special rights to change the device settings using SMS commands. By default, this number receives SMS alarm messages. This can be changed by deactivation the alarm notification checkbox.

“Master” will receive SMS for loss of internet connectivity if checkbox “Connectivity alert” is activated. This checkbox is activated by default.

Number format for Master must be in E.164 international standard (ITU-T Recommendation), that ensures each device on the PSTN has a globally unique number. This allows calls and text messages to be correctly routed.

The remaining 4 recipients can receive SMS messages if any of the parameters are in an alarm state. To receive the SMS messages for every number should be enabled with the checkbox “Alarm Notification”. These 4 recipients can also ask by SMS for parameter state/value.

Activating checkbox “Superuser rights” gives special rights to 4 users. Users can send all SMS commands as the “Master”, except for commands to create new users and change the “Master”.

Number format for Users can be in E.164 international standard or short codes 3-8 digits.

A short code is a number that is used for high-volume SMS message sending. Short codes are often used for application-to-person (A2P) messaging.

A short code typically contains between three and seven digits, depending on the country or region that it's based in. The short codes can be only used to send messages to recipients in the same country where the short code is based.

By pressing the “Send test SMS” button all SMS recipients will receive a test SMS.

All commands, their syntax, and answers are described in “Setup via SMS”.

SMS is not a reliable communication and it is not recommended as a monitoring technology.

## 7.2.2. 1-Wire sensors setup

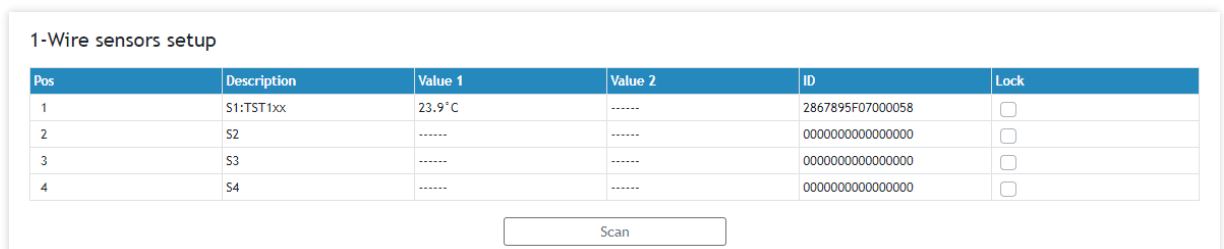

| Pos | Description | Value 1 | Value 2 | ID               | Lock                     |
|-----|-------------|---------|---------|------------------|--------------------------|
| 1   | S1:TST1xx   | 23.9°C  | -----   | 2867895F07000058 | <input type="checkbox"/> |
| 2   | S2          | -----   | -----   | 0000000000000000 | <input type="checkbox"/> |
| 3   | S3          | -----   | -----   | 0000000000000000 | <input type="checkbox"/> |
| 4   | S4          | -----   | -----   | 0000000000000000 | <input type="checkbox"/> |

Scan

Detection of connected 1-Wire sensors is made either after power on or by the button “Scan”. All found sensors are shown in ascending order refer to their unique ID number.

It is possible to lock a 1-Wire sensor in a specific position. To do this all sensors should be added one by one. After every addition, a new scan should be made and a newly found sensor should be locked in its position. If all sensors are locked, removing one “in the middle” will not change the positions of other sensors after reset. This option is very useful when TCG120-4 is used as a part of a monitoring and control system managed by HTTP API commands.

## 7.2.3. Input/Output

### 7.2.3.1. Sensors

Sensors

| Sensor # | Description | Unit | Multiplier | Offset |  |
|----------|-------------|------|------------|--------|--|
| S1       | S1:TSH230   | °C   | 1.000      | 0.00   |  |
|          |             | %RH  | 1.000      | 0.00   |  |
| S2       | S2          | ---  |            |        |  |
|          |             | ---  |            |        |  |
| S3       | S3          | ---  |            |        |  |
|          |             | ---  |            |        |  |
| S4       | S4          | ---  |            |        |  |
|          |             | ---  |            |        |  |

For every sensor, a description, up to 15 symbols can be set. These descriptions will appear in the monitoring page, conditions page, XML/JSON data, SMS, and e-mail alerts.

For some sensors, fields “Unit”, “Multiplier” and “Offset” are available to convert the raw values into meaningful units. The scaled value is calculated by:

$$SV[Un] = RV * MU + OF$$

Where:

SV – scaled (displayed) value;

Un – unit;

RV – raw value from the sensor;

MU – multiplier;

OF – offset.

### 7.2.3.2. Digital inputs

| Digital inputs |                 |           |            |  |  |
|----------------|-----------------|-----------|------------|--|--|
| Input #        | Description     | Low level | High level |  |  |
| DI1            | Digital Input 1 | CLOSED    | OPEN       |  |  |
| DI2            | Digital Input 2 | CLOSED    | OPEN       |  |  |

For every digital input, a description, up to 15 symbols and states up to 15 symbols can be set. These descriptions will appear in the monitoring page, conditions page, XML/JSON data, SMS, and e-mail alerts.

### 7.2.3.3. Analog inputs

| Analog inputs |                |      |            |        |      |
|---------------|----------------|------|------------|--------|------|
| Input #       | Description    | Unit | Multiplier | Offset | Type |
| AI1           | Analog Input 1 | V    | 1.000      | 0.0000 |      |
| AI2           | Analog Input 2 | V    | 1.000      | 0.0000 |      |

For every analog input, a description, up to 15 symbols can be set. These descriptions will appear in the monitoring page, conditions page, XML/JSON data, SMS, and e-mail alerts.



For every analog input, fields “Unit”, “Multiplier” and “Offset” are available to convert the raw voltage/current into meaningful engineering units. The scaled value is calculated by:

$$SV[Un] = RV * MU + OF$$

Where:

SV – scaled (displayed) value;

Un – unit;

RV – raw voltage from the source;

MU – multiplier;

OF – offset.

Example:

For humidity sensor HIH-4000-003 following data (from the datasheet) is available:

VOUT = 0.826 at 0% RH

VOUT = 3.198 at 75.3% RH

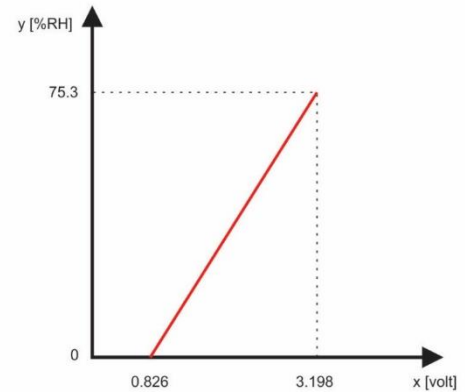

The sensor provides raw voltage values as output, but what we actually need is the corresponding relative humidity values. To achieve this, we use a multiplier and an offset. These two parameters allow us to calculate the relative humidity for any given voltage within the sensor's working range.

The multiplier (MU) is determined by the ratio of the change in relative humidity ( $\Delta RH\%$ ) to the change in voltage ( $\Delta V$ ). In geometric terms, this is akin to finding the slope of a line. For this particular sensor, the line is described by the equation  $\Delta RH\% / \Delta V$ . We can calculate the multiplier as follows:

$$MU = (75.3 - 0) / (3.198 - 0.826) = 75.3 / 2.372 = 31.745 \%RH/V$$

The offset (OF) is calculated using the multiplier and the relation between one of the known points. By substituting the scaled value (SV) and the corresponding raw value (RV) into the equation  $SV = RV * MU + OF$ , we can solve for the offset:

$$OF = SV - (RV * MU)$$

Using the point where  $SV = 0$  and  $RV = 0.826$ , we find:

$$OF = 0 - (0.826 * 31.745) = 0 - 26.22 = -26.22$$

Similarly, we can calculate the offset using the other point, where  $SV = 75.3$  and  $RV = 3.198$ :

$$OF = 75.3 - (3.198 * 31.745) = 75.3 - 101.52 = -26.22$$

Therefore, the formula for this sensor becomes:

$$SV = RV * 31.745 - 26.22$$

To verify the accuracy of this formula, let's check the case where  $VOUT = 0.826$  V (0%RH):

$$SV = 0.826 * 31.745 - 26.22 = 26.22 - 26.22 = 0 \%RH$$

This confirms that the formula correctly converts the voltage to the corresponding relative humidity value.

### 7.2.3.4. Relay outputs

| Relay outputs |                                      |                                  |   |  |  |
|---------------|--------------------------------------|----------------------------------|---|--|--|
| Relay #       | Description                          | Pulse (seconds)                  | Activated from                              | Action on alarm/event                  |  |
| R1            | <input type="text" value="Relay 1"/> | <input type="text" value="0.1"/> | <input type="text" value="SMS/HTTP API"/> ▾ | <input type="text" value="Turn on"/> ▾ |  |
| R2            | <input type="text" value="Relay 2"/> | <input type="text" value="0.2"/> | <input type="text" value="SMS/HTTP API"/> ▾ | <input type="text" value="Turn on"/> ▾ |  |

Relays state after restart  ▾

For every relay, a description, up to 15 characters can be set. These descriptions will appear in the monitoring page, XML/JSON data, SMS and e-mail alerts.

The pulse duration can be different for every relay. The resolution is 0.1 second, the maximum pulse value is 3600 seconds.

All relays can be activated either remotely by SMS/HTTP API or locally from the status of a monitored parameter. This setting is made from the “Activated from” drop-down menu, the possible options are:

- **SMS/HTTP** - by selecting this option the relay outputs can be activated by SMS from an authorized number or by sending HTTP API commands;
- **Local activation.**

For local activation, alarm conditions for different sources are used. They are set up in section “Setup->Conditions”. To assign a parameter to the relay, the following choices are possible:

- **S?** – “S” stands for “Sensor 1-Wire”. The relay is activated from the value measured from the specified 1-Wire sensor and rules for ranges specified in “Setup->Conditions”. Question mark masks a number from 1 to 4;
- **Analog input?**. The relay is activated from the value measured by specified analog input and rules for ranges specified in “Setup->Conditions”. Question mark masks a number from 1 to 2;
- **Digital input?**. The relay follows the state of the specified digital input. Question mark masks a number from 1 to 2;
- **Any alarm.** The relay is activated on any alarm condition.

All changes in the above sections are saved by pressing the “Save” button.

## 7.2.4. Conditions

This section is used for parameterization of trigger and alert conditions for sensors, analog, and digital inputs.

### 7.2.4.1. Sensors and analog inputs

Sensors
If out of range

| # | Description | Type | Parameter       | Min   | Max   | Hys  | mail                     | sms                      | post                     | mqtt                     |
|---|-------------|------|-----------------|-------|-------|------|--------------------------|--------------------------|--------------------------|--------------------------|
| 1 | S1:TSH2xx   |      | Temperature, °C | -40.0 | 85.0  | 8.5  | <input type="checkbox"/> | <input type="checkbox"/> | <input type="checkbox"/> | <input type="checkbox"/> |
|   |             |      | Humidity, %RH   | 0.0   | 100.0 | 10.0 | <input type="checkbox"/> | <input type="checkbox"/> | <input type="checkbox"/> | <input type="checkbox"/> |
| 2 | S2          |      | ...             | ...   | ...   | ...  | <input type="checkbox"/> | <input type="checkbox"/> | <input type="checkbox"/> | <input type="checkbox"/> |
|   |             |      | ...             | ...   | ...   | ...  | <input type="checkbox"/> | <input type="checkbox"/> | <input type="checkbox"/> | <input type="checkbox"/> |
| 3 | S3          |      | ...             | ...   | ...   | ...  | <input type="checkbox"/> | <input type="checkbox"/> | <input type="checkbox"/> | <input type="checkbox"/> |
|   |             |      | ...             | ...   | ...   | ...  | <input type="checkbox"/> | <input type="checkbox"/> | <input type="checkbox"/> | <input type="checkbox"/> |
| 4 | S4          |      | ...             | ...   | ...   | ...  | <input type="checkbox"/> | <input type="checkbox"/> | <input type="checkbox"/> | <input type="checkbox"/> |
|   |             |      | ...             | ...   | ...   | ...  | <input type="checkbox"/> | <input type="checkbox"/> | <input type="checkbox"/> | <input type="checkbox"/> |

Notification in case of a sensor communication lost

Return notification 
 Notification delay (seconds)  (0-3600)

Analog inputs
If out of range

| # | Description    | Dimension | Min   | Max    | Hys   | mail                     | sms                      | post                     | mqtt                     |
|---|----------------|-----------|-------|--------|-------|--------------------------|--------------------------|--------------------------|--------------------------|
| 1 | Analog Input 1 | V         | 0.000 | 30.000 | 1.000 | <input type="checkbox"/> | <input type="checkbox"/> | <input type="checkbox"/> | <input type="checkbox"/> |
| 2 | Analog Input 2 | V         | 0.000 | 30.000 | 1.000 | <input type="checkbox"/> | <input type="checkbox"/> | <input type="checkbox"/> | <input type="checkbox"/> |

Return notification 
 Notification delay (seconds)  (0-3600)

For every sensor two types of fields are presented – one for the trigger conditions (“Min”, “Max”, and “Hys.”) and another one for the wanted action.

“Min” and “Max” indicate the border of the working range for the monitored parameter. The “Max” trigger condition occurs when the value exceeds the trigger set point. The “Min” trigger condition occurs when the value is lower than the trigger set point. In both cases, the monitored parameter goes out of range.

Coming back in range for the observed parameter is considered when the value goes higher than (Min + Hys) or lower than (Max – Hys). Hysteresis (“Hys”) is used to prevent excessively triggering when the value fluctuates around the trigger point.

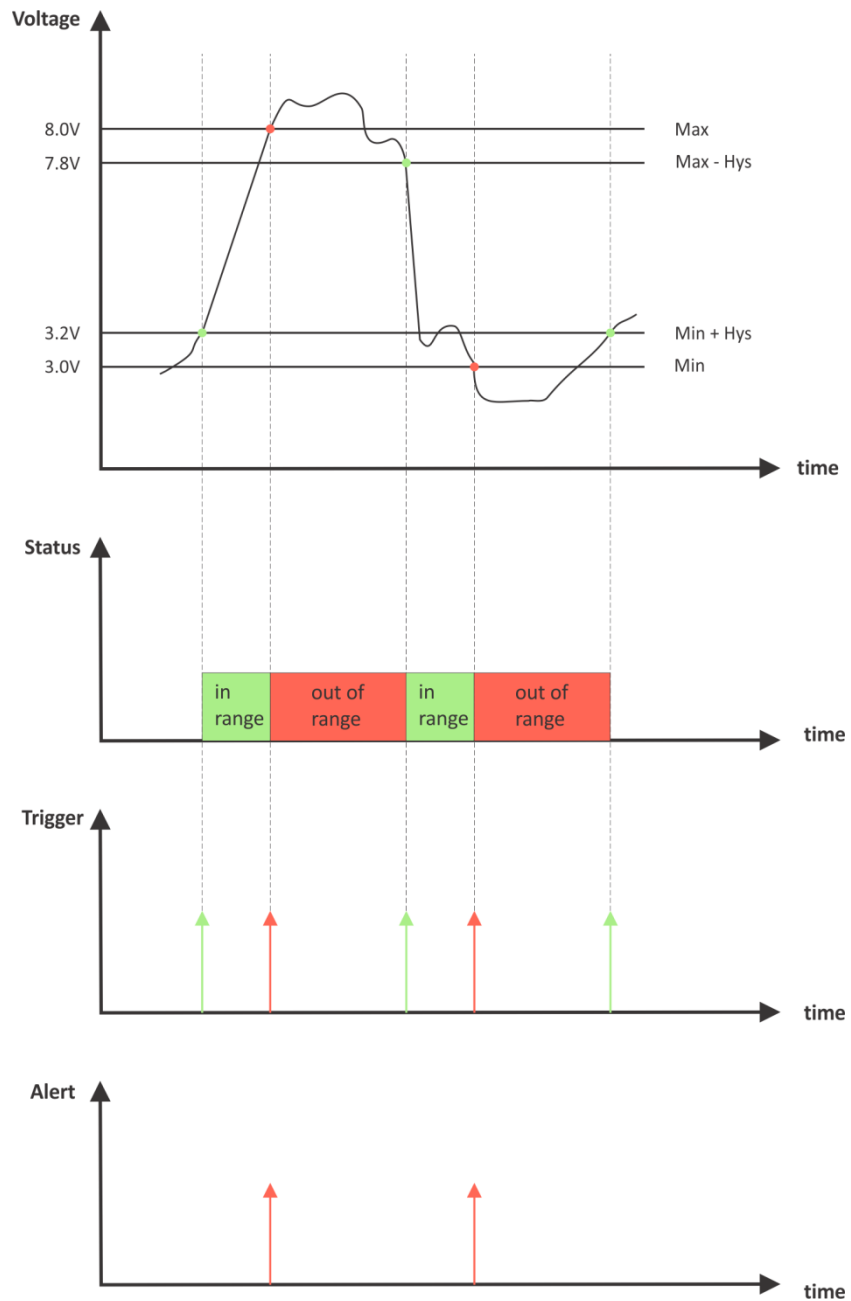

**Example:**

*TCG120-4, TST100, and an appropriate heater are used to control the room temperature. The wanted minimum temperature is 19°C. The initial temperature is 17°C.*

TST100 is assigned on the first position for 1-Wire sensors.

For Relay1 local activation from Sensor1 is set.

Following parameters are set for Sensor1: Min=19, Max=100 and Hys=0.5.

| Sensors |             |      |                 |     |     |     | If out of range                     |                                     |                          |                          |
|---------|-------------|------|-----------------|-----|-----|-----|-------------------------------------|-------------------------------------|--------------------------|--------------------------|
| #       | Description | Type | Parameter       | Min | Max | Hys | mail                                | sms                                 | post                     | mqtt                     |
| 1       | S1:TSH2xx   | 1W   | Temperature, °C | 19  | 100 | 0.5 | <input checked="" type="checkbox"/> | <input checked="" type="checkbox"/> | <input type="checkbox"/> | <input type="checkbox"/> |

When the module is switched on, Relay1 is immediately activated because the monitored temperature is out of range. This switches the heater on. The temperature is going higher.

When temperature reaches 19.5°C (19.0 + 0.5) it goes in range (trigger condition) and Relay1 is deactivated. The heater is switched off.

The temperature falls and when it reached 19°C it goes out of range (trigger and alert conditions). The relay is activated (heater is switched on) and e-mail is sent.

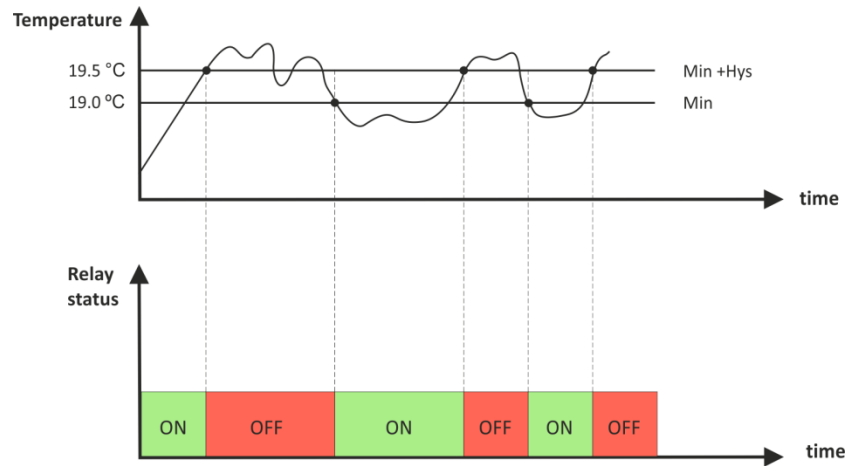

The “Max” value is set far enough from the wanted temperature to avoid trigger/alert conditions around it.

For every sensor or analog input, there are 4 independent ways of alert when there is an alarm condition – email, SMS, post (HTTP Post with XML/JSON file) and MQTT publish. Each alarm notification method is activated by a checkbox.

There is a notification by email, SMS, post and MQTT in case of a sensor communication lost. Each notification method is activated by a checkbox.

Globally for all sensors and for all analog inputs, there is a checkbox “Return notification”. If this option is chosen there will be a notification also when the parameter returns in range.

Globally for all sensors and for all analog inputs, there is a “Notification delay” parameter. It is very useful as a filter for short alarm conditions.

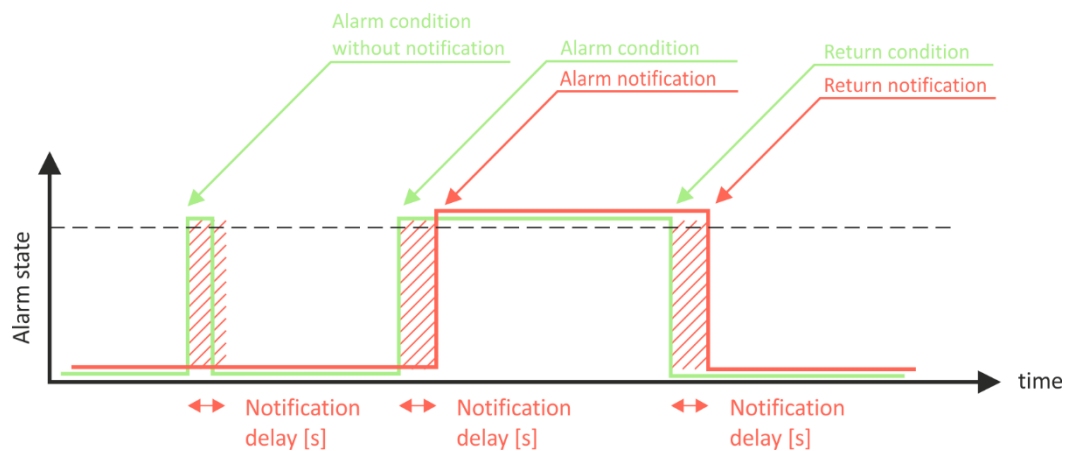

### 7.2.4.2. Digital inputs

| Digital inputs |                 |               |                    |                           |                           | On active alarm          |                          |                          |                                     |
|----------------|-----------------|---------------|--------------------|---------------------------|---------------------------|--------------------------|--------------------------|--------------------------|-------------------------------------|
| #              | Description     | Current state | Select alarm state | Low to high delay, 0-3600 | High to low delay, 0-3600 | mail                     | sms                      | post                     | mqtt                                |
| 1              | Digital Input 1 | OPEN          | CLOSED             | 0.0                       | 0.0                       | <input type="checkbox"/> | <input type="checkbox"/> | <input type="checkbox"/> | <input checked="" type="checkbox"/> |
| 2              | Digital Input 2 | OPEN          | CLOSED             | 0.0                       | 0.0                       | <input type="checkbox"/> | <input type="checkbox"/> | <input type="checkbox"/> | <input checked="" type="checkbox"/> |

Return notification  Notification delay (seconds)  (0-3600)

For every digital input, the alarm state should be chosen. The texts are already set on the “Input/output” page.

When the input goes in alarm state 4 independent way of the alert are possible – email, SMS, post (HTTP Post with XML/JSON file) and MQTT publish. Each alarm notification method is activated by a checkbox.

Globally for all digital inputs, there is a checkbox “Return notification”. If this option is chosen there will be a notification also when the parameter returns in range.

Globally for all digital inputs, there is a “Notification delay” parameter. It is useful as a filter for short alarm conditions.

In the time when the input is in an alarm state, on the „Monitoring page“, the appropriate input will be colored in red.

There are two delays - low-to-high and high-to-low for digital input change. These delays are added to the standard delay of 30ms. They have 0.1-second resolution and by default are zero.

These options can be used for additional filtering.

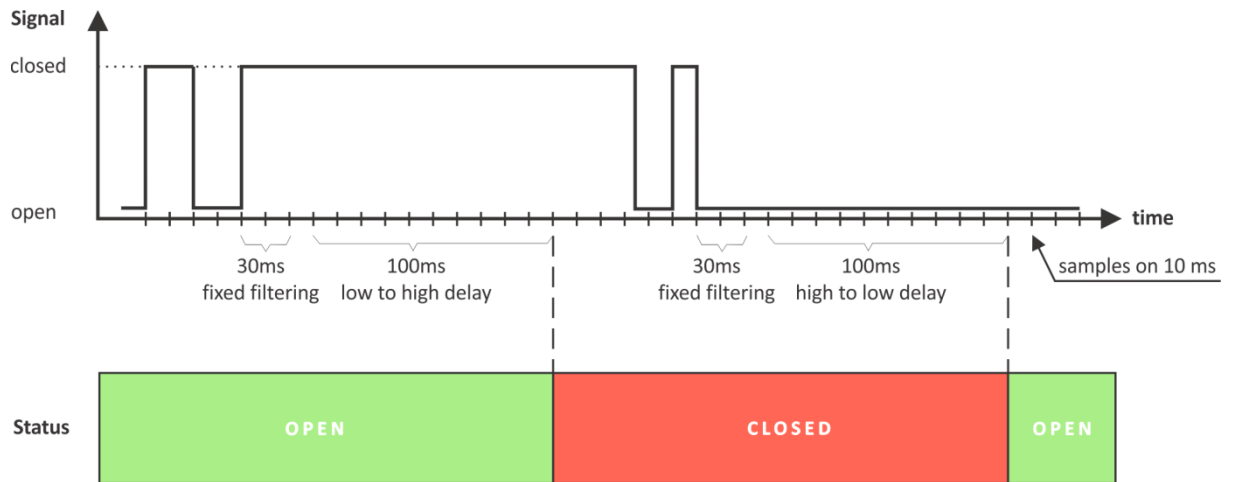

On the picture above low-to-high and high-to-low delays are set to 0.1 seconds.

## 7.2.5. System

The page for some general settings.

### 7.2.5.1. System status

| System status            |                 |                         |                          |
|--------------------------|-----------------|-------------------------|--------------------------|
| Network registration     | Yes             | Enable data in roaming  | <input type="checkbox"/> |
| Data connection          | Yes             | Home network            | Yes                      |
| Signal strenght          | -69dBm(70%)     | Service                 | 1,LTE,Online             |
| Service provider         | VIVACOM         | IP address              | 10.132.140.20            |
| Mobile Country Code(MCC) | 284             | Location Area Code(LAC) | 2500                     |
| Mobile Network Code(MNC) | 03              | Cell ID(CID)            | 1327940                  |
| IMEI                     | 866011053310108 | MFW version             | A011B08A7672M7           |

There is information about the general status of the module here.

The only possible setting here is the “Data in roaming” checkbox. By default, it is disabled to avoid extra charges for data transfer in roaming.

If you are using another operator's card, you must activate “Data in roaming”. Otherwise, you will not be able to use all data services – emails, HTTP Post, NTP, etc.

### 7.2.5.2. Data connection setup

| Data connection setup |                                       |
|-----------------------|---------------------------------------|
| APN                   | <input type="text" value="internet"/> |
| Username              | <input type="text"/>                  |
| Password              | <input type="text"/>                  |



This setting can be different for each mobile operator. By default, APN (Access Point Name) is “internet”. Some mobile operators may require also a username and password.

### 7.2.5.3. Mobile network connection reset

For areas with low signal strength or where the mobile network frequently drops/blocks, automatic restarting of the network connection can be used. This could prevent permanently losing the connection with the device.

The automatic restart will be done once per day.

By default, the automatic restart is disabled.

#### Mobile network connection reset

Automatic network connection reset

Time of the reset(hh:mm:ss)

### 7.2.5.4. General setup

#### General setup

|                   |  |                |                                     |
|-------------------|--|----------------|-------------------------------------|
| Temperature units | <input type="text" value="Celsius"/>                 | 1-Wire sensors | <input checked="" type="checkbox"/> |
| Pressure units    | <input type="text" value="hPa"/>                     | Analog inputs  | <input checked="" type="checkbox"/> |
| Host name         | <input type="text" value="TCG120-4"/>                | Digital inputs | <input checked="" type="checkbox"/> |
| Writing mode      | <input type="text" value="left-to-right"/>           | Relay outputs  | <input checked="" type="checkbox"/> |
| System name       | <input type="text" value="TCG120-4"/>                |                |                                     |
| System location   | <input type="text" value="Location"/>                |                |                                     |
| System contact    | <input type="text" value="info@teracomsystems.com"/> |                |                                     |

The section is for some general settings.

The temperature and pressure units can be changed with preferable ones.

Writing mode change the alignment in the WEB interface and SMS.

Hostname, System name, System location and System contact are sent in XML/JSON files and can be used for flexible identification of the device. These parameters can be also included in the body of the e-mails.

The checkboxes on the right define what to see on the “Monitoring page”. By default, they all are enabled.

### 7.2.5.5. Device restart

In this section, there are buttons for device restart and reset to factory default settings.

Device restart

### 7.2.6. NTP

#### Time setup

NTP server IP/URL

Time zone

Period (h)

If not found (h)

#### Uptime

Uptime 0days,00:03:35

#### NTP test

|              |                     |
|--------------|---------------------|
| Current time | 10.09.2021,11:09:53 |
| Last updated | 10.09.2021,11:09:48 |
| Status       | OK                  |

Internal RTC (real-time clock) of the module can be set only automatically.

For automatic clock synchronization, the module supports NTP (Network Time Protocol) and all necessary parameters for automatic synchronization are available in this section.

The clock synchronization is made on the set “Period”. If the attempt was not successful, the next synchronization will be on “If not found” time.

Pressing the “Save and synchronize” button initiates time synchronization. The information for “Status” in the blue box is very useful for the availability of the time server and the Internet at all.

The current system time is sent in an XML/JSON file when HTTP Post is enabled.

By default, NTP synchronization is enabled, server – time.google.com:123, Time zone 00.00 and period of 12 hours.

The settings and service at all can be checked with the available tools in the NTP Test section.

## 7.3. Services

### 7.3.1. SMTP

This page is used to enter valid SMTP settings for email alerts and recipients' addresses.

#### 7.3.1.1. SMTP setup

SMTP setup

|                              |   |
|------------------------------|---|
| Mail server IP/URL           | <input type="text" value="mail.teracomsystems.com"/>    |
| Mail server port             | <input type="text" value="465"/>                        |
| Type of encrypted connection | <input type="text" value="SSL/TLS"/>                    |
| Sender e-mail                | <input type="text" value="support@teracomsystems.com"/> |
| Username                     | <input type="text" value="support@teracomsystems.com"/> |
| Password                     | <input type="password" value="....."/>                  |

Mail server address can be set either by hostname (for example mail.teracomsystems.com) or IP address.

By default, without encrypted connection, SMTP port is 25. Ask ISP if default port doesn't work.

Sender e-mail, username, and password are standard authentication details. For most SMTP servers, sender e-mail and username are the same.

There is a button for server settings test with a feedback. In this test sender and recipient of the e-mail is the same.

Transport Layer Security protocol is used for secure communication with public mail servers. TCG120-4 supports TLS 1.0, TLS 1.1 and TLS 1.2 with RSA as a key exchange/agreement and authentication, which ensures successful operation with almost all public servers. STARTTLS is not supported.

#### 7.3.1.2. Alarm destination

Alarm destinations

|                  |   |                                     |
|------------------|---|-------------------------------------|
| Recipient e-mail | <input type="text" value="john_smith@gmail.com"/> | <input checked="" type="checkbox"/> |
| Recipient e-mail | <input type="text" value="test@gmail.com"/>       | <input checked="" type="checkbox"/> |
| Recipient e-mail | <input type="text"/>                              | <input type="checkbox"/>            |
| Recipient e-mail | <input type="text"/>                              | <input type="checkbox"/>            |
| Recipient e-mail | <input type="text"/>                              | <input type="checkbox"/>            |

Up to 5 email recipients can be set. Every recipient can be activated independently by a checkbox.

### 7.3.1.3. E-mail details

| Subject, header and footer variables | Body variables                      |
|--------------------------------------|-------------------------------------|
| #N System Name                       | #D Sensor Description               |
| #L System Location                   | #V Measured Value                   |
| #C System Contact                    | #U Unit of measured value           |
| #A IP Address of device              | #T Time stamp of message            |
| #M ID of device                      | #S Status of parameter-ALARM/NORMAL |
| #H Hostname                          | #I ID of message                    |
|                                      | #W LoW limit                        |
|                                      | #G High limit                       |

The subject, body header, body, and body footer can be customized. For this customization, a set of keys is used. All they are described on the page.

### 7.3.2. XML/JSON file HTTP Post

HTTP Post is used for periodically upload of an XML/JSON file to a server by HTTP/HTTPS requests (Post method). The file contains the current status of all monitored parameters and extra system information. The file format is chosen from the drop-down menu.

The HTTP servers can be addressed either by domain name or IP address.

The "Period" can be set between 1 min and 48 hours. This parameter can be changed remotely by a command. The "Period" determines at what time the control software receives up-to-date information from TCG120-4 and can, therefore, make changes to some of the parameters. The shorter is "Period", the closer to the real-time operation is the system. On the other hand, as shorter is the "Period" as higher is the data traffic through the mobile network.

If the checkbox "Connect on any alarm" is selected, HTTP Post will be sent on any alarm.

The "Key" field is user-defined. Its value is available in XML/JSON file and can be used for device identification.

If "Process Answer" is enabled, TCG120-4 will execute the commands, sent by the remote server as an answer of HTTP/HTTPS Post.

More about HTTP/HTTPS Post can be read in the HTTP API section.

## 7.4. MQTT

Device supports MQTT 3.1.1. This page is for the MQTT settings.

### 7.4.1. MQTT General

MQTT setup

|                    |                                       |                                     |
|--------------------|---------------------------------------|-------------------------------------|
| MQTT               | <input type="text" value="Enable"/>   |                                     |
| Data format        | <input type="text" value="JSON"/>     |                                     |
| MQTT mode          | <input type="text" value="unsecure"/> |                                     |
| Server             | <input type="text"/>                  | <input type="button" value="Test"/> |
| Port               | <input type="text" value="1883"/>     |                                     |
| Username           | <input type="text"/>                  |                                     |
| Password           | <input type="text"/>                  |                                     |
| Period <i>i</i>    | <input type="text" value="00:05:00"/> |                                     |
| Client ID <i>i</i> | <input type="text" value="TCG120-4"/> |                                     |
| Name topic         | <input type="text" value="TCG120-4"/> |                                     |

### 7.4.2. MQTT Sensors topic

Sensors

Sensors topic name

| Sensor # | Topic                           | Publish value                     | Publish state                     |
|----------|---------------------------------|-----------------------------------|-----------------------------------|
| S1       | <input type="text" value="11"/> | <input type="checkbox"/> <i>i</i> | <input type="checkbox"/> <i>i</i> |
|          | <input type="text" value="12"/> | <input type="checkbox"/> <i>i</i> | <input type="checkbox"/> <i>i</i> |
| S2       | <input type="text" value="21"/> | <input type="checkbox"/> <i>i</i> | <input type="checkbox"/> <i>i</i> |
|          | <input type="text" value="22"/> | <input type="checkbox"/> <i>i</i> | <input type="checkbox"/> <i>i</i> |
| S3       | <input type="text" value="31"/> | <input type="checkbox"/> <i>i</i> | <input type="checkbox"/> <i>i</i> |
|          | <input type="text" value="32"/> | <input type="checkbox"/> <i>i</i> | <input type="checkbox"/> <i>i</i> |
| S4       | <input type="text" value="41"/> | <input type="checkbox"/> <i>i</i> | <input type="checkbox"/> <i>i</i> |
|          | <input type="text" value="42"/> | <input type="checkbox"/> <i>i</i> | <input type="checkbox"/> <i>i</i> |

### 7.4.3. MQTT analog inputs topic

Analog inputs

Analog inputs topic name

| Analog input # | Topic                          | Publish value                     | Publish state                     |
|----------------|--------------------------------|-----------------------------------|-----------------------------------|
| AI1            | <input type="text" value="1"/> | <input type="checkbox"/> <i>i</i> | <input type="checkbox"/> <i>i</i> |
| AI2            | <input type="text" value="2"/> | <input type="checkbox"/> <i>i</i> | <input type="checkbox"/> <i>i</i> |

## 7.4.4. MQTT digital inputs topic

Digital inputs

Digital inputs topic name

| Digital input # | Topic                          | Publish value                     | Publish state                     |
|-----------------|--------------------------------|-----------------------------------|-----------------------------------|
| DI1             | <input type="text" value="1"/> | <input type="checkbox"/> <i>i</i> | <input type="checkbox"/> <i>i</i> |
| DI2             | <input type="text" value="2"/> | <input type="checkbox"/> <i>i</i> | <input type="checkbox"/> <i>i</i> |

## 7.5. GSM geolocation

GSM geolocation is a way to determine the position without the use of GPS. Only information from the mobile network is used. The information is sent to a third-party operator that returns the coordinates of the device with some accuracy.

The positioning is more inaccurate compared to GPS, but it also works indoors. It is especially suitable for tracking parcels, refrigerated display cases, refrigerators, machines and equipment operating where there is no GPS signal.

TCG120-4 supports the following operators - Google, Quectel, and Unwired Labs. The service needs registration with the operator.

GSM geolocation setup

Geolocation

Geolocation provider

Server

Token / API key

Request period (seconds) *i*  288 Requests per day

Latitude 43.835283

Longitude 25.965967

Google maps location <https://www.google.bg/maps/place/43.835283,25.965967>

Server message ---

OK

## 7.6. Administration

### 7.6.1. Backup/Restore

Backup/Restore configuration

Select configuration file

TCG120-4 supports backup and restore of all user settings. All settings are saved in an XML backup file. This file can be used after this to restore the same settings on many devices. This is very useful for multiplying similar settings to a batch of modules.



## 7.6.2. FW update

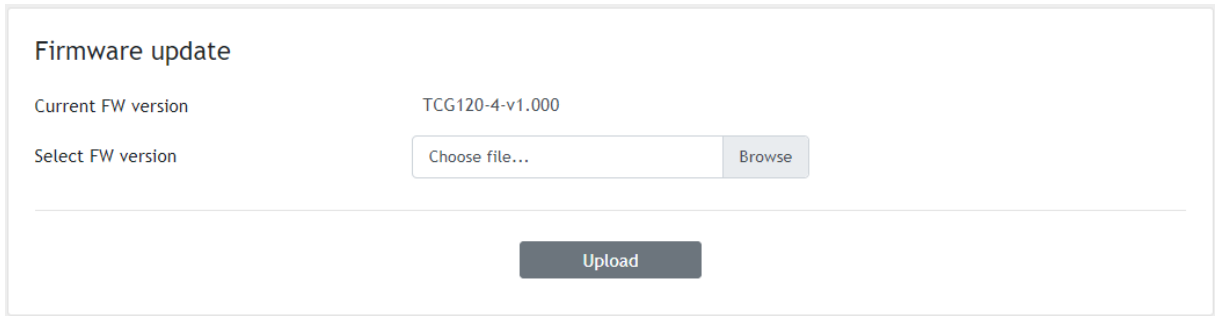

Firmware update

Current FW version TCG120-4-v1.000

Select FW version

TCG120-4 supports firmware update over the WEB interface.

Download the latest firmware from [www.teracomsystems.com](http://www.teracomsystems.com), choose the file, and press the “upload” button.

**Attention!** Don’t turn off the power supply during the update. Turning off the power supply will damage the device.

## 8. Setup via SMS

TCG120-4 supports SMS commands for parameter change, status reports, and firmware update over the air. The commands will be executed only if they come from the phone numbers available in the section "SMS setup". The commands need different rights (master/user).

Below is a list of the supported SMS commands. Note that the underscore character “\_” must be replaced by one space character.

- **Set new master number**

Rights: Master

Syntax: set\_master\_<number>

Where

<number> is a mobile number in the international format

*Example*

*Command:* set master +359885885885

*Answer:* You are the new master!

- **Set SMS users numbers** - this message is used to add/delete SMS users

Rights: Master

Syntax: set\_sms\_user\_<user>:<number>

Where

<number> is a mobile number in the international format

<user> can be u1, u2, u3 or u4

*Example*

*Command:* set sms user u1:+359885887766

*Answer:* u1:+359885887766,u2,u3,u4

*Command:* set sms user u2:+359885999888

*Answer:* u1:+359885887766, u2:+359885999888,u3,u4

*Command:* set sms user u1:

*Answer:* u1, u2:+359885999888,u3,u4

- **Set superuser rights for users** - this message is used to activate/deactivate superuser rights for SMS users

Rights: Master  
 Syntax: set\_suser\_<user>=<cmd>  
 Where  
 <cmd> is "on" for activation or "off" for deactivation  
 <user> can be u1, u2, u3 or u4

*Example*

Command: set suser u1=on  
 Answer: m:+ 359885885885,su1:+359885887767,u2,u3,u4  
 Command: set suser u1=off  
 Answer: m:+ 359885885885,u1:+359885887767,u2,u3,u4  
 Command: set suser u1=off,u2=on,u3=off,u4=off  
 Answer: m:+ 359885885885,u1:+359885887761,su2:+359885887762,  
 u3:+359885887763,u4:+359885887764

- **Display SMS users numbers**

Rights: Master, Superusers, Users  
 Syntax: display\_sms\_users

*Example*

Command: display sms users  
 Answer: m:+359885885885,u1:+359885887766,u2:+359885999888,u3,u4

- **Set email users** - this message is used to add/delete email users

Rights: Master, Superusers  
 Syntax: set\_email\_user\_<user>:<email>  
 Where  
 <email> - a valid email address  
 <user> can be e1, e2, e3, e4 or e5

*Example*

Command: set email user e1:mail1@teracomsystems.com  
 Answer: e1:mail1@teracomsystems.com  
 Command: set email user e2:mail2@teracomsystems.com  
 Answer: e2:mail2@teracomsystems.com  
 Command: set email user e2:  
 Answer: e2:

- **Display email users** - this message is used to request the email of a user

Rights: Master, Superusers, Users  
 Syntax: display\_email\_<user>  
 Where  
 <user> can be one of: e1, e2, e3, e4 or e5

*Example*

Command: display email e1  
 Answer: e1:mail1@teracomsystems.com  
 Command: display email e2  
 Answer: e2:mail2@teracomsystems.com

- **Status of system** - requests main parameters of the device

Rights: Master, Superusers, Users  
 Syntax: status\_system

*Example*

*Command:* status system

*Answer:*

06.01.2021,16:09:06,4G=y,ss=80%,fw=1.00

- **Status of parameter** - requests status of digital input (di), analog input (ai), relay (r) and sensor(s)

Rights: Master, Superusers, Users  
 Syntax: status\_<param>

Where

<param> is one of: di1, di2, ai1, ai2, r1, r2, s11, s12, s21, s22, s31, s32, s41, s42

*Example*

*Command:* status di1

*Answer:* di1(Garage\_door)=CLOSED

*Command:* status s22

*Answer:* s22(Office)=34.5%RH

- **Set a relay** - this message is used to switch on/off the selected relay output

Rights: Master, Superusers, Users  
 Syntax: set\_<relay>=<state>\_[option]

Where

<relay> is r1 or r2

<state> is on, off

[option] -w

*Example*

*Command:* set r1=on

*Answer:* r1=on,r2=off

*Command:* set r1=off

*Answer:* r1=off,r2=off

*Command:* set r1=off,r2=on

*Answer:* r1=off,r2=on

*Command:* set r1=on -w

*Answer:* no answer

*Command:* set r1=off,r2=off -w

*Answer:* no answer

- **Set pulse a relay** - this message is used to pulse the selected relay output

Rights: Master, Superusers, Users  
 Syntax: set\_<pulse relay>=<state>\_[option]

Where

< pulse relay > is pl1 or pl2

<state> is on

[option] -w

*Example*

*Command:* set pl1=on

*Answer:* r1=on,r2=off

*Command:* set pl1=on,pl2=on  
*Answer:* r1=on,r2=on

*Command:* set pl1=on -w  
*Answer:* no answer

*Command:* set pl1=on,pl2=on -w  
*Answer:* no answer

- **Post URL** – sets URL for XML/JSON HTTP Post

*Rights:* Master, Superusers  
*Syntax:* set\_purl=<link> or set\_purl2=<link>  
Where  
<link> is the address of remote server (domain or IP)

*Example*

*Command:* set purl=www.teracomsystems.com:8801/posttest.php  
*Answer:* purl=www.teracomsystems.com:8801/posttest.php,post=on,period=00:01:00

*Command:* set purl2=www.teracomsystems.com:8802/posttest.php  
*Answer:* purl2=www.teracomsystems.com:8802/posttest.php,post=on,period=00:01:00

- **Status URL** – status URL's for XML/JSON HTTP Post

*Rights:* Master, Superusers, Users  
*Syntax:* status\_purl or status\_purl2

*Example*

*Command:* status purl  
*Answer:* purl=www.teracomsystems.com:8801/posttest.php,post=on,period=00:01:00

*Command:* status purl2  
*Answer:* purl2=www.teracomsystems.com:8802/posttest.php,post=on,period=00:05:00

- **Post period in seconds** – sets XML/JSON HTTP Post period in seconds

*Rights:* Master, Superusers  
*Syntax:* set\_pper=<value>  
Where  
<value> is a number between 60 and 172800 (seconds)

*Example*

*Command:* set pper=120  
*Answer:* post=off,period=00:02:00

- **Post period in hh:mm:ss** – sets XML/JSON HTTP Post period in hh:mm:ss

*Rights:* Master, Superusers  
*Syntax:* set\_pperh=<value>  
Where  
<value> is a number between 00:01:00 and 48:00:00

*Example*

*Command:* set pper=00:05:00  
*Answer:* post=off,period=00:05:00

- **Post on** – sets XML/JSON HTTP Post on

*Rights:* Master, Superusers

Syntax: set\_post=on

*Example*

*Command:* set post=on

*Answer:* post=on,period=00:02:00

- **Post off** – sets XML/JSON HTTP Post off

Rights: Master, Superusers

Syntax: set post=off

*Example*

*Command:* set post=off

*Answer:* post=off,period=00:02:00

- **MQTT on** – sets MQTT on

Rights: Master, Superusers

Syntax: set\_mqtt=on

*Example*

*Command:* set mqtt=on

*Answer:* mqtt=on,mdata=json,period=00:05:00

- **MQTT off** – sets MQTT off

Rights: Master, Superusers

Syntax: set\_mqtt=off

*Example*

*Command:* set mqtt=off

*Answer:* mqtt=off,mdata=json,period=00:05:00

- **MQTT period** – sets MQTT publish period

Rights: Master, Superusers

Syntax: set\_mper=<time>

Where

<time> is between 00:01:00 and 48:00:00 (hh:mm:ss)

*Example*

*Command:* set mper=00:05:00

*Answer:* mqtt=on,mdata=json,period=00:05:00

- **MQTT data** – sets MQTT data format

Rights: Master, Superusers

Syntax: set\_mdata=<format>

Where

<format> is “json” or “plain”

*Example*

*Command:* set mdata=plain

*Answer:* mqtt=on,mdata=plain,period=00:05:00

- **MQTT server** – sets MQTT server

Rights: Master, Superusers

Syntax: set\_murl=<link>

Where

<link> is the address of remote server (domain or IP)

*Example*

*Command:* `set murl= www.teracomsystems.com`

*Answer:* `mqtt=on,murl= www.teracomsystems.com,port=1883`

- **MQTT port** – sets MQTT port

*Rights:* Master, Superusers

*Syntax:* `set_mport=<port>`

Where

<port> is a MQTT port

*Example*

*Command:* `set mport= 8883`

*Answer:* `mqtt=on,murl= www.teracomsystems.com,port=8883`

- **Set a time server**

*Rights:* Master, Superusers

*Syntax:* `set_ts=url:port`

*Example*

*Command:* `set ts=time.google.com:123`

*Answer:* `ts=time.google.com:123,tz=+02:00`

- **Set a time zone**

*Rights:* Master, Superusers

*Syntax:* `set_tz=±hh:mm`

*Example*

*Command:* `set tz=+03:00`

*Answer:* `ts=time.google.com:123,tz=+03:00`

- **Restart** – restarts the device

*Rights:* Master, Superusers

*Syntax:* `restart`

*Example*

*Command:* `restart`

*Answer:* `Device is restarting!`

- **Send test email** – a message for sending a test email to the email users

*Rights:* Master, Superusers

*Syntax:* `test_email`

*Example*

*Command:* `test email`

*Answer:* `Emails are sending!`

- **Send test SMS** – a message for sending a test SMS to the authorized users

*Rights:* Master, Superusers

*Syntax:* `test_sms`

*Example*

*Command:* `test sms`

*Answer:* `This is a test SMS!`

- **Update** – a message for update the device over the air (needs LTE/WCDMA/GPRS)

Rights: Master, Superusers

Syntax: update\_<URL>

Where

<URL> is a valid URL to public server, pointing update (.cod) file

*Example*

*Command:* update www.teracomsystems.com/docs/TCG120-4-v1.000-P-S.cod

*Answer 1:* Downloading firmware...

*Answer 2:* Firmware file downloaded. Updating...

Following answers are also possible in different situations:

*Answer:* File corrupt or wrong version!

*Answer:* Can't connect to server!

*Answer:* Download time out!

*Answer:* 4G/3G/2G is not connected!

*Answer:* Connection lost!

*Answer:* Response timeout!

*Answer:* Socket error!

- **Set Mobile network connection reset**

Rights: Master, Superusers

Syntax: set mncr=<status>,hh:mm:ss

Where

<status> - "on" or "off"

*Example:* enable mobile network connection reset and set time

*Command:* set mncr=on,10:00:00

*Answer:* mncr=on,10:00:00

*Example:* disable mobile network connection reset

*Command:* set mncr=off

*Answer:* mncr=off,10:00:00

- **Set a sensor notification delay**

Rights: Master, Superusers

Syntax: set delsen=xxxx

where

xxxx – notification delay in seconds (0-3600)

*Example:*

*Command:* set delsen=5

*Answer:* delsen=5

- **Set a sensor limits**

Rights: Master, Superusers

Syntax: set lspt=naaaa,xbbbb,ycccc

where

**p** sensor number; valid values 1,2,3 or 4;

**t** parameter of the sensor; valid values 1 or 2;

**n** stands for "Min"

aaaa value for limit "Min";

**x** stands for "Max"



bbbb value for limit "Max"  
y stands for "Hys"  
cccc value for "Hys".

*Example: set of sensor 1 parameter 1 (temperature):*

*Command: set ls11=n25.0,x35.0,y1.0*

*Answer: ls11=n25.0,x35.0,y1.0*

*Command: set ls11=n31.0*

*Answer: ls11=n31.0,x35.0,y1.0*

*Example: set of sensor 1 parameter 2 (humidity):*

*Command: set ls12=n45.0,x60.0,y1.0*

*Answer: ls12=n45.0,x60.0,y1.0*

- **Set API command. Execute full list of HTTP API commands - Appendix C.**

Rights: Master, Superusers

Syntax: set api **cmd**=**value**

where

**cmd** API command

**value** API value

*Example: set APN for data connection*

*Command: set api APN=internet*

*Answers: OK (If executed successfully)*

*Wrong or missing parameters! (if not executed successfully)*

*Unknown command! (if not executed successfully)*

*Example: activation of email alarm notification for digital input 1*

*Command: set api d1m=1*

*Answer: OK*

*Example: deactivation of email alarm notification for digital input 1*

*Command: set api d1m=0*

*Answer: OK*

## 9. Protocols and API

### 9.1. HTTP API

HTTP is a very popular protocol for the implementation of remote monitoring and control SCADA systems. These systems are built on client-server technology.

TCG120-4 supports client mode – HTTP/HTTPS Post. This makes the device compatible with all SCADA software running HTTP protocol.

### 9.2. XML/JSON file HTTP Post

When this service is active, the module periodically sends the HTTP Post to a server. The Post contains an XML or JSON file with the current status of monitored parameters.

HTTP and HTTPS protocols are supported.

The Post can be sent also on an alarm condition - as an analogy of the SNMP trap.

On every HTTP Post, the server returns a response in accordance with the HTTP protocol. Only if "Process Answer" is enabled, TCG120-4 will execute the commands, contained in the answer. Otherwise, the device will terminate the connection immediately after the response.

A very important parameter in this communication is the HTTP Post period. With a shorter time period the device generates more data traffic, but this keeps the information and possibility to control the device closer to "real-time".

The HTTP Post period can be changed by the server with the appropriate HTTP command. This makes communication very flexible.

### 9.2.1. Commands

The commands for TCG120-4 are sent in the answer's body of HTTP Post request. The structure of command is:

set yyy=xxx

Where:

yyy is the command;

xxx is the parameter.

Example:

set r1=on – will turn on the relay 1.

set FIN – will terminate the session.

The full list of the commands is available on 9.4.

### 9.2.2. Typical communication session

Below is a typical communication session between TCG120-4 and a remote server, with "Process Answer" enabled:

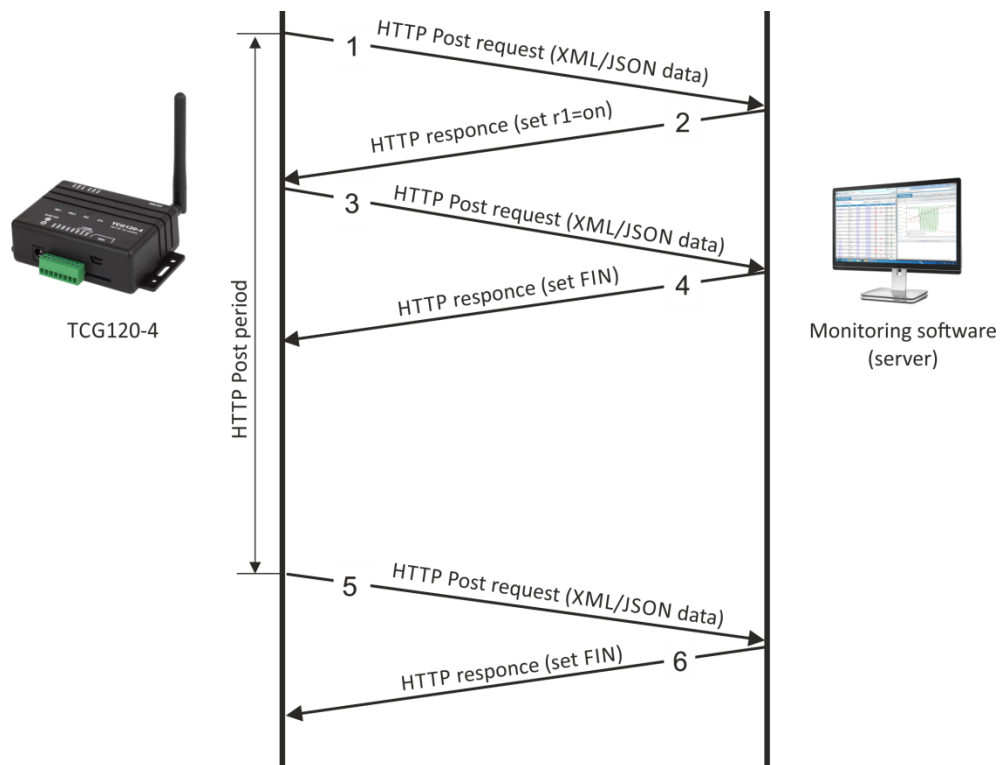

- The device sends HTTP Post request (1) with XML/JSON data to the remote server either on Post period or on alarm condition;
- The server returns HTTP response (2), which contains "set r1=on" command as a brief text in the message body;
- The device sends a new HTTP Post request (3) with updated XML/JSON data, which confirms the execution of "set r1=on" command;

- The server returns a new HTTP response (4), which includes “set FIN” in the message body. This indicates that there are no pending commands and the session can be closed;
- On next HTTP Post period, TCG120-4 sends a new HTTP Post request (5) to the server;
- The server answers with “set FIN” (6) – there are no pending commands and the session can be closed.

A typical monitoring application is shown below:

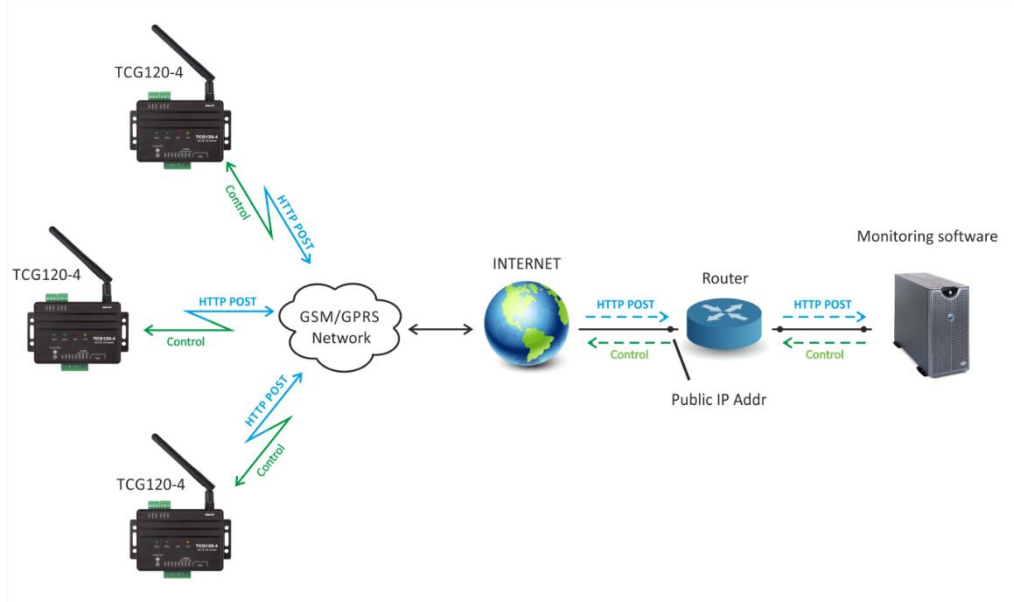

XML/JASON HTTP Post service can be tested following the steps below:

- Save following code like post.php:

```
<?php
define("FILENAME", 'status.xml');
define("FOLDER", "");
define("SEPARATOR", "");
define("STR_SUCCESS", 'set FIN');
define("STR_ERROR", 'error');

if($_SERVER['REQUEST_METHOD'] == 'POST'){
    $datePrefix = date('YmdHis', strtotime('now'));
    $pathname = FOLDER.SEPARATOR.$datePrefix.'_' . FILENAME;
    $postdata = file_get_contents("php://input");
    $handle = fopen($pathname, 'w+');
    $content = var_export($postdata, true);
    fwrite($handle, substr($content, 1, strlen($content)-2));
    fclose($handle);
    echo (($handle === false) ? STR_ERROR : STR_SUCCESS)."\r\n";
}
else {
    echo "The PHP script is working!";
}
?>
```

- Copy the *post.php* file on a WEB server with PHP support. The server should have visibility from the Internet. The UniServer and XAMP are the most popular WEB servers for Windows.
- To verify that the script is working properly, type the URL (for example [www.yourserverURL.com/post.php](http://www.yourserverURL.com/post.php)) in the WEB browser. If all is OK, a WEB page with “The PHP script is working!” will be shown.
- Activate XML/JASON HTTP Post service to [www.yourserverURL.com/post.php](http://www.yourserverURL.com/post.php).
- Click on the “Test HTTP Post” button.

- If the HTTP Post is received and processed, “OK” will be shown close to the button. Along with this, an XML/JSON file will be created in the same directory, where *post.php* is located. The file name will contain time information. For example - 20210601103318\_status.xml.

### 9.3. Short list of HTTP API commands

TCG120-4 supports following HTTP commands (case sensitive):

| Command     | Description   |
|-------------|---|
| rn=xxx      | Turn relay <b>n</b> ON (xxx=on) or OFF (xxx=off)<br>( <b>n</b> is 1 or 2 for the respective relay)<br>r1=on – will turn relay 1 ON<br>r2=off – will turn relay 2 OFF<br>r1=on&r2=on – will turn all relays ON<br>r1=off&r2=off – will turn all relays OFF |
| rn=tg       | Toggle relay <b>n</b><br>( <b>n</b> is 1 or 2 for the respective relay)<br>r2= tg – will toggle relay 2<br>r1=tg&r2=tg – will toggle relay 1 and 2  |
| rn=pl       | Pulse relay <b>n</b><br>( <b>n</b> is 1 or 2 for the respective relay)<br>r1=pl – will pulse relay 1<br>r1=pl&r2=pl   |
| vnf=10.0    | Set Min of analog input to 10.0<br>( <b>f</b> is 1 or 2 for the respective input)<br>vn1=10.0 will set Min for analog input 1   |
| vxf=20.0    | Set Max of analog input to 20.0<br>( <b>f</b> is 1 or 2 for the respective input)<br>vx2=20.0 will set Max for analog input 2   |
| vyf=1.0     | Set Hys of analog input to 1.0<br>( <b>f</b> is 1 or 2 for the respective input)<br>Vy1=1.0 will set Hys for analog input 1   |
| snpt=30.0   | Set Min of sensor to 30.0<br>( <b>p</b> is 1,2,3 or 4 for the respective sensor<br><b>t</b> is 1 or 2 for the respective parameter of sensor)<br>sn12=30.0 will set Min for sensor 1, parameter 2   |
| sxpt=40.0   | Set Max of sensor to 40.0<br>( <b>p</b> is 1,2,3 or 4 for the respective sensor<br><b>t</b> is 1 or 2 for the respective parameter of sensor)<br>sx42=40.0 will set Min for sensor 4, parameter 2   |
| sypt=2.0    | Set Hys of sensor to 2.0<br>( <b>p</b> is 1,2,3 or 4 for the respective sensor<br><b>t</b> is 1 or 2 for the respective parameter of sensor)<br>sy31=2.0 will set Hys for sensor 3, parameter 1   |
| delsen=xxxx | Notification delay for sensors<br>(xxxx is between 0 and 3600)  |
| delanl=xxxx | Notification delay for analog inputs<br>(xxxx is between 0 and 3600)  |
| deldig=xxxx | Notification delay for digital inputs<br>(xxxx is between 0 and 3600)   |
| dda1=xxxx   | Low to high delay for digital input 1<br>(xxxx is between 0 and 3600)   |
| ddd1=xxxx   | High to low delay for digital input 1<br>(xxxx is between 0 and 3600)   |
| dda2=xxxx   | Low to high delay for digital input 2   |

|                |   |
|----------------|---|
|                | (xxxx is between 0 and 3600)  |
| ddd2=xxxx      | High to low delay for digital input 2<br>(xxxx is between 0 and 3600)   |
| dataf=x        | Data format XML/JSON for HHTP Post – 0 XML, 1 JSON  |
| purl=yyy       | URL for XML/JSON HTTP Post to Server 1, where yyy is a full path to php file<br>purl=212.25.45.120:30181/xampp/test/pushtest.php  |
| purl2=yyy      | URL for XML/JSON HTTP Post to Server 2, where yyy is a full path to php file<br>purl=212.25.45.120:30181/xampp/test/pushtest.php  |
| pper=x         | XML/JSON HTTP Post period in seconds<br>(x is between 60 and 172800)<br>pper=600 – will set Post period to 600 seconds  |
| pperh=hh:mm:ss | XML/JSON HTTP Post period in format hh:mm:ss<br>pperh=01:00:00 – will set Post period on 1 hour   |
| dk=xxx         | XML/JSON HTTP Post key – xxx is up to 17 characters   |
| mdata=x        | Data format JSON/Plain text for MQTT Publish – 0 JSON, 1 Plain text   |
| mmode=x        | Publish protocol, where x is 0 for unsecure and 1 for TLS/SSL   |
| muser=xxxx     | Username authentication for MQTT, where xxxx is a username  |
| mpass=xxxx     | Password authentication for MQTT, where xxxx is a password  |
| murl=yyy       | URL for MQTT publish, where yyy is a path<br>murl=212.25.45.120   |
| mport=yyyy     | Port for MQTT publish, where yyyy is a port<br>mport=1883   |
| mper=x         | MQTT publish period in seconds<br>(x is between 60 and 172800)<br>mper=600 – will set MQTT publish period to 600 seconds  |
| save           | Save all previous changes (except relays' one) in the FLASH memory.<br><b>As every save reflects the FLASH cycles (endurance), this command should be used very carefully.</b><br>pper=120&save – will set Post period to 120 seconds and save it |
| FIN            | Terminate the session   |

Multiply commands are sent concatenated with “&”.

The commands are sent in the answer on XML/JSON or CSV HTTP Posts. They are executed if “Process Answer” is enabled.

#### 9.4. Full list of HTTP API commands

Please see Appendix C.

#### 9.5. File structures

For XML file structure please see Appendix A.

For JSON file structure please see Appendix B.

#### 9.5. MQTT

MQTT is a Client-Server publish/subscribe messaging transport protocol. It is lightweight, open, simple, and designed so as to be easy to implement. MQTT is used in a wide variety of industries, such as automotive, manufacturing, telecommunications, oil, gas and etc.

More about MQTT can be read at [www.mqtt.org](http://www.mqtt.org).

## 10. Firmware update

TCG120-4 supports firmware update over the WEB interface and over the air.

For firmware update over the WEB interface please see 7.4.2. FW update.

For firmware update over the air (needs 4G LTE/3G/2G connection) please follow the steps below:

- Upload the update file (.cod extension) on public HTTP server ;
- Send firmware update command (the syntax of the SMS message is described in 8. Setup via SMS).

**Attention!** Only the Master and Superusers can send this message.

The firmware will be downloaded and verified. The download takes about 3 minutes. If the file is correct, the Master will receive a confirmation SMS message. The update procedure takes about 2 minutes. Once the firmware update is complete (about 5 minutes), TCG120-4 will restart.

**Attention!** Don't turn off the power supply during the update. Turning off the power supply will damage the device.

## 11. Factory default settings

TCG120-4 can be restored to its factory default settings by the following steps:

- Turn off the power supply;
- Press and hold the RESET button then turn on the power supply;
- STA and SIG LEDs will turn ON;
- Release the RESET button.

The module will restore its default settings.

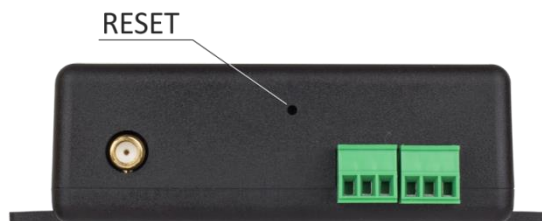

## 12. Environment information

This equipment is intended for use in a Pollution Degree 2 environment, at altitudes up to 2000 meters. When the module is a part of a system, the other elements of the system shall comply with the EMC requirements and shall be intended for use in the same ambient conditions.

## 13. Safety

This device must not be used for medical, life-saving purposes or for any purpose where its failure could cause serious injury or the loss of life.



This product contains a coin/button cell battery. Do not ingest battery, Chemical Burn Hazard.

If the coin/button cell battery is swallowed, it can cause severe internal burns in just 2 hours and can lead to death.

Keep new and used batteries away from children.

If the battery compartment does not close securely, stop using the product and keep it away from children.

If you think batteries might have been swallowed or placed inside any part of the body, seek immediate medical attention.



To reduce the risk of fire, only flexible stranded wire, with cross-section 0.5mm<sup>2</sup> or larger for wiring of digital and analog inputs and relay output of the device should be used.

To avoid electric shock and fire hazards, do not expose this product to liquids, rain, or moisture. Objects filled with liquids, such as vases, should not be placed on this device.

There is a risk of overheating (damage) of the module, if recommended free spaces to adjacent devices are not ensured. Joint part with external component shall have space for attachment/removal of the cable after installation.

Teracom does not guarantee a successful operation of the product if the product was used under conditions deviating from the product specifications.

## **14. Maintenance**

Upon completion of any service or repairs to the device or once per year, a safety check must be performed to determine that this product is in proper operating condition. Clean the device only with a dry cloth. Do not use a liquid cleaner or an aerosol cleaner. Do not use a magnetic/static cleaning device (dust remover) or any kind of abrasive materials to clean the device.

## **15. Package content**

The box contains:

- TCG120-4
- Multi-band antenna - 698 to 960 and 1710 to 2690MHz
- Quick start guide

The XML file (status.xml) structure:

```

<Monitor>
  <DeviceInfo>
    <DeviceName>TCG120-4</DeviceName>
    <HostName>TCG120-4</HostName>
    <ID>867648045420609</ID>
    <FwVer>TCG120-4-v1.000</FwVer>
    <MnflInfo>www.teracomsystems.com</MnflInfo>
    <SysContact>info@teracomsystems.com</SysContact>
    <SysName>TCG120-4</SysName>
    <SysLocation>Location</SysLocation>
  </DeviceInfo>
  <S>
    <S1>
      <description>S1:TSH230</description>
      <id>010140C6E8FFCE65</id>
      <type>1Wire</type>
      <item1>
        <value>29.5</value>
        <unit>°C</unit>
        <alarm>0</alarm>
        <min>-40.0</min>
        <max>50.0</max>
        <hys>0.5</hys>
      </item1>
      <item2>
        <value>51.1</value>
        <unit>%RH</unit>
        <alarm>0</alarm>
        <min>0.0</min>
        <max>60.0</max>
        <hys>1.0</hys>
      </item2>
    </S1>
    <S2>
      <description>S2</description>
      <id>0000000000000000</id>
      <type>1Wire</type>
      <item1>
        <value>---</value>
        <unit>---</unit>
        <alarm>0</alarm>
        <min>---</min>
        <max>---</max>
        <hys>---</hys>
      </item1>
      <item2>
        <value>---</value>
        <unit>---</unit>
        <alarm>0</alarm>
        <min>---</min>
        <max>---</max>
        <hys>---</hys>
      </item2>
    </S2>
    <S3>
      <description>S3</description>
      <id>0000000000000000</id>
      <type>1Wire</type>
      <item1>
        <value>---</value>
        <unit>---</unit>
        <alarm>0</alarm>
        <min>---</min>
        <max>---</max>
      </item1>
    </S3>
  </S>
</Monitor>

```



```

    <hys>---</hys>
  </item1>
  <item2>
    <value>---</value>
    <unit>---</unit>
    <alarm>0</alarm>
    <min>---</min>
    <max>---</max>
    <hys>---</hys>
  </item2>
</S3>
<S4>
  <description>S4</description>
  <id>0000000000000000</id>
  <type>1Wire</type>
  <item1>
    <value>---</value>
    <unit>---</unit>
    <alarm>0</alarm>
    <min>---</min>
    <max>---</max>
    <hys>---</hys>
  </item1>
  <item2>
    <value>---</value>
    <unit>---</unit>
    <alarm>0</alarm>
    <min>---</min>
    <max>---</max>
    <hys>---</hys>
  </item2>
</S4>
</S>
<AI>
  <AI1>
    <description>Analog Input 1</description>
    <value>3.240</value>
    <unit>V</unit>
    <multiplier>1.000</multiplier>
    <offset>0.0000</offset>
    <alarm>0</alarm>
    <min>0.000</min>
    <max>30.000</max>
    <hys>1.000</hys>
  </AI1>
  <AI2>
    <description>Analog Input 2</description>
    <value>3.202</value>
    <unit>V</unit>
    <multiplier>1.000</multiplier>
    <offset>0.0000</offset>
    <alarm>0</alarm>
    <min>0.000</min>
    <max>30.000</max>
    <hys>1.000</hys>
  </AI2>
</AI>
<DI>
  <DI1>
    <description>Digital Input 1</description>
    <value>OPEN</value>
    <valuebin>1</valuebin>
    <alarmState>CLOSED</alarmState>
    <alarm>0</alarm>
  </DI1>
  <DI2>
    <description>Digital Input 2</description>
    <value>OPEN</value>

```

```

    <valuebin>1</valuebin>
    <alarmState>CLOSED</alarmState>
    <alarm>0</alarm>
  </DI2>
</DI>
<R>
  <R1>
    <description>Relay 1</description>
    <value>OFF</value>
    <valuebin>0</valuebin>
    <pulseWidth>0.1</pulseWidth>
    <control>0</control>
  </R1>
  <R2>
    <description>Relay 2</description>
    <value>OFF</value>
    <valuebin>0</valuebin>
    <pulseWidth>0.2</pulseWidth>
    <control>0</control>
  </R2>
</R>
<HTTPPush>
  <Key/>
  <PushPeriod>180</PushPeriod>
</HTTPPush>
<MQTT>
  <Period>300</Period>
</MQTT>
<signalpercent>77</signalpercent>
<hwerr>[Uncalibrated]</hwerr>
<Alarmed>0</Alarmed>
<Scannig>Scan</Scannig>
<Time>
  <Date>11.08.2021</Date>
  <Time>07:26:07</Time>
</Time>
<NetworkInfo>
  <Name>A1 BG A1 BG</Name>
  <SC>
    <MCC>284</MCC>
    <MNC>01</MNC>
    <LAC>28201</LAC>
    <CID>3587</CID>
    <SQ>-65</SQ>
  </SC>
  <Latitude>43.835283</Latitude>
  <Longitude>25.965967</Longitude>
</NetworkInfo>
</Monitor>

```

Where:

*<value>--- </value> and <unit>--- </unit> means no 1-Wire sensor on this position;  
 <alarm>1</alarm> means there is a trigger condition.*

The JSON file (status.json)structure:

```
{
  "Monitor": {
    "DeviceInfo": {
      "DeviceName": "TCG120-4",
      "HostName": "TCG120-4",
      "ID": "862632040544279",
      "FwVer": "TCG120-4-v1.000",
      "MnfInfo": "www.teracomsystems.com",
      "SysContact": "info@teracomsystems.com",
      "SysName": "TCG120-4",
      "SysLocation": "Location"
    },
    "S": {
      "S1": {
        "description": "S1:TST230",
        "id": "010140C6E8FFCE65",
        "type": "1W",
        "item1": {
          "value": "29.0",
          "unit": "°C",
          "alarm": "0",
          "min": "-40.0",
          "max": "50.0",
          "hys": "0.5"
        },
        "item2": {
          "value": "51.1",
          "unit": "%RH",
          "alarm": "0",
          "min": "0",
          "max": "60",
          "hys": "1.0"
        }
      },
      "S2": {
        "description": "S2",
        "id": "0000000000000000",
        "type": "1W",
        "item1": {
          "value": "---",
          "unit": "---",
          "alarm": "0",
          "min": "---",
          "max": "---",
          "hys": "---"
        },
        "item2": {
          "value": "---",
          "unit": "---",
          "alarm": "0",
          "min": "---",
          "max": "---",
          "hys": "---"
        }
      },
      "S3": {
        "description": "S3",
        "id": "0000000000000000",
        "type": "1W",
        "item1": {
          "value": "---",
          "unit": "---",
          "alarm": "0",
          "min": "---",
          "max": "---",
          "hys": "---"
        }
      }
    }
  }
}
```

```

        "max": "---",
        "hys": "---"
    },
    "item2": {
        "value": "---",
        "unit": "---",
        "alarm": "0",
        "min": "---",
        "max": "---",
        "hys": "---"
    }
},
"S4": {
    "description": "S4",
    "id": "0000000000000000",
    "type": "1W",
    "item1": {
        "value": "---",
        "unit": "---",
        "alarm": "0",
        "min": "---",
        "max": "---",
        "hys": "---"
    },
    "item2": {
        "value": "---",
        "unit": "---",
        "alarm": "0",
        "min": "---",
        "max": "---",
        "hys": "---"
    }
}
},
"AI": {
    "AI1": {
        "description": "Analog Input 1",
        "value": "0.000",
        "unit": "V",
        "multiplier": "1.000",
        "offset": "0.0000",
        "alarm": "0",
        "min": "0.000",
        "max": "2.000",
        "hys": "0.010"
    },
    "AI2": {
        "description": "Analog Input 2",
        "value": "0.000",
        "unit": "V",
        "multiplier": "1.000",
        "offset": "0.0000",
        "alarm": "0",
        "min": "0.000",
        "max": "2.000",
        "hys": "0.010"
    }
},
"DI": {
    "DI1": {
        "description": "Digital Input 1",
        "value": "OPEN",
        "valuebin": "1",
        "alarmState": "CLOSED",
        "alarm": "0"
    },
    "DI2": {
        "description": "Digital Input 2",

```

```

    "value": "OPEN",
    "valuebin": "1",
    "alarmState": "CLOSED",
    "alarm": "0"
  }
},
"R": {
  "R1": {
    "description": "Relay 1",
    "value": "OFF",
    "valuebin": "0",
    "pulseWidth": "0.1",
    "control": "0"
  },
  "R2": {
    "description": "Relay 2",
    "value": "OFF",
    "valuebin": "0",
    "pulseWidth": "0.2",
    "control": "0"
  }
},
"HTTPPush": {
  "Key": "",
  "PushPeriod": "300"
},
"MQTT": {
  "Period": "300"
},
"signalpercent": "67",
"hwerr": "",
"Alarmed": "0",
"Scannig": "Scan",
"Time": {
  "Date": "11.08.2021",
  "Time": "11:39:55"
},
"NetworkInfo": {
  "Name": "A1 BG A1 BG",
  "SC": {
    "MCC": "284",
    "MNC": "01",
    "LAC": "28201",
    "CID": "3587",
    "SQ": "-71"
  },
  "Latitude": 43.835283,
  "Longitude": 25.965967
}
}
}

```

## Full list of HTTP API commands

TCG120-4 supports following HTTP commands (case sensitive):

| Command             | Description   |
|---------------------|---|
| <b>Monitoring</b>   |   |
| rn=xxx              | Turn relay <b>n</b> ON (xxx=on) or OFF (xxx=off)<br>( <b>n</b> is 1 or 2 for the respective relay)<br>r1=on – will turn relay 1 ON<br>r2=off – will turn relay 2 OFF<br>r1=on&r2=on – will turn all relays ON<br>r1=off&r2=off – will turn all relays OFF   |
| rn=tg               | Toggle relay <b>n</b><br>( <b>n</b> is 1 or 2 for the respective relay)<br>r2= tg – will toggle relay 2<br>r1=tg&r2=tg – will toggle relay 1 and 2  |
| rn=pl               | Pulse relay <b>n</b><br>( <b>n</b> is 1 or 2 for the respective relay)<br>r1=pl – will pulse relay 1<br>r1=pl&r2=pl   |
| <b>SMS</b>          |   |
| unumfn=x            | Set SMS number format for Users - short codes (x=0) or E.164 international format (x=1)<br>( <b>n</b> is 1,2,3 or 4 for the respective user)<br>SMS number format for Master is E.164 international standard only and can't be changed.<br>unumf1=0 – set short code number format for User1<br>unumf2=1 – set E.164 international format for User2 |
| srn=xxx             | Set SMS number <b>n</b><br>( <b>n</b> is 0 for master and 1,2,3 or 4 for the respective user)<br>sr0= +359885180709 – set Master number. E.164 international format is mandatory.<br>sr1=57575701 – set User1 number in short code format.<br>Before this command must be set SMS number format - short codes or E.164 international format.        |
| conal=x             | Set connectivity alert for Master - activation (x=1) or deactivation (x=0)  |
| susern=x            | Set superuser rights for users - activation (x=1) or deactivation (x=0)<br>suser1=1 – activation superuser right for User 1<br>suser2=0 – deactivation superuser right for User 2   |
| ualn=x              | Activation (x=1) or deactivation (x=0) of alarm notification<br>( <b>n</b> is 0 for master and 1,2,3 or 4 for the respective user)<br>ual0=1 – activation alarm notification for Master<br>ual1=1 – deactivation alarm notification for User 1  |
| <b>Input/Output</b> |   |
| sdn=xxx             | Set sensor <b>n</b> description<br>( <b>n</b> is 1,2,3 or 4 for the respective sensor)<br>sd1=S1-Temp – set sensor 1 description  |
| adn=xxx             | Set analog input <b>n</b> description<br>( <b>n</b> is 1 or 2 for the respective analog input)<br>ad1=AN1 – set analog input 1 description  |
| aun=xxx             | Set analog input <b>n</b> unit  |

|                   |   |
|-------------------|---|
|                   | (n is 1 or 2 for the respective analog input)<br>au1=VDC – set analog input 1 unit  |
| amn=x.xxx         | Set analog input n multiplier<br>(n is 1 or 2 for the respective analog input)<br>am1=2.000 – set analog input 1 multiplier   |
| aon=x.xxxx        | Set analog input n offset<br>(n is 1 or 2 for the respective analog input)<br>ao1=0.0005 – set analog input 1 offset  |
| ddn=xxx           | Set digital input n description<br>(n is 1 or 2 for the respective digital input)<br>dd1=DIN1 – set digital input 1 description   |
| dln=xxx           | Set digital input n low level description<br>(n is 1 or 2 for the respective digital input)<br>dl1=CLOSED – set low level description for digital input 1   |
| dhn=xxx           | Set digital input n high level description<br>(n is 1 or 2 for the respective digital input)<br>dh1=OPEN – set high level description for digital input 1   |
| rdn=xxx           | Set relay n description<br>(n is 1 or 2 for the respective relay)<br>rd1=REL1 – set relay 1 description   |
| rpn=x.x           | Set relay n pulse time in seconds<br>(n is 1 or 2 for the respective relay)<br>rp1=0.5 – set relay 1 pulse time to 0.5 sec  |
| rcn=xx            | Set relay n activated from xx<br>(n is 1 or 2 for the respective relay)<br>Where xx:<br>SMS/HTTP API(0),<br>S11(1), S12(2), S21(3), S22(4),<br>S31(5), S32(6), S41(7), S42(8), Analog input 1(9), Analog<br>input 2(10), Digital input 1(11), Digital input 2(12), Any<br>Alarm(13)<br>rc1=13 – set relay 1 activated from Any alarm<br>rc2=0 – set relay 2 activated from SMS/HTTP API |
| aaen=x            | Set relay n action on alarm – Turn on(x=0) or Single<br>pulse(x=2)<br>(n is 1 or 2 for the respective relay)<br>aaen1=0 – set relay 1 action on alarm Turn on   |
| snpt=30.0         | Set Min of sensor to 30.0<br>(p is 1,2,3 or 4 for the respective sensor<br>t is 1 or 2 for the respective parameter of sensor)<br>sn12=30.0 will set Min for sensor 1, parameter 2  |
| sxpt=40.0         | Set Max of sensor to 40.0<br>(p is 1,2,3 or 4 for the respective sensor<br>t is 1 or 2 for the respective parameter of sensor)<br>sx42=40.0 will set Min for sensor 4, parameter 2  |
| sypt=2.0          | Set Hysteresis of sensor to 2.0<br>(p is 1,2,3 or 4 for the respective sensor<br>t is 1 or 2 for the respective parameter of sensor)<br>sy31=2.0 will set Hys for sensor 3, parameter 1   |
| <b>Conditions</b> |   |
| sxym=b            | Activation (b=1)/deactivation (b=0) of Mail alarm<br>notification for sensor x, part y<br>(x is 1,2,3 or 4 for the respective sensor<br>y is 1 or 2 for the respective parameter of sensor)   |

|             |   |
|-------------|---|
|             | s11m=1 – activation mail alarm notification for sensor 1, part 1  |
| sxys=b      | Activation (b=1)/deactivation (b=0) of SMS alarm notification for sensor x, part y<br>(x is 1,2,3 or 4 for the respective sensor<br>y is 1 or 2 for the respective parameter of sensor)<br>s21s=1 – activation sms alarm notification for sensor 2, part 1                |
| sxyp=b      | Activation (b=1)/deactivation (b=0) of HTTP post alarm notification for sensor x, part y<br>(x is 1,2,3 or 4 for the respective sensor<br>y is 1 or 2 for the respective parameter of sensor)<br>s12p=1 – activation of HTTP post alarm notification for sensor 1, part 2 |
| sxyq=b      | Activation (b=1)/deactivation (b=0) of MQTT alarm notification for sensor x, part y<br>(x is 1,2,3 or 4 for the respective sensor<br>y is 1 or 2 for the respective parameter of sensor)<br>s22q=1 – activation of MQTT alarm notification for sensor 2, part 2           |
| sclm=x      | Mail notification in case of a sensor communication lost - activation (x=1) or deactivation (x=0)   |
| scls=x      | SMS notification in case of a sensor communication lost - activation (x=1) or deactivation (x=0)  |
| sclp=x      | HTTP post notification in case of a sensor communication lost - activation (x=1) or deactivation (x=0)  |
| sclq=x      | MQTT notification in case of a sensor communication lost - activation (x=1) or deactivation (x=0)   |
| srn=x       | Return notification for sensors - activation (x=1) or deactivation (x=0)  |
| delsen=xxxx | Notification delay for sensors<br>(xxxx is between 0 and 3600)  |
| delsen=xxxx |   |
| vnf=10.0    | Set Min of analog input to 10.0<br>(f is 1 or 2 for the respective input)<br>vn1=10.0 will set Min for analog input 1   |
| vxf=20.0    | Set Max of analog input to 20.0<br>(f is 1 or 2 for the respective input)<br>vx2=20.0 will set Max for analog input 2   |
| vyf=1.0     | Set Hys of analog input to 1.0<br>(f is 1 or 2 for the respective input)<br>Vy1=1.0 will set Hys for analog input 1   |
| anm=b       | Mail alarm notification for analog input - activation (b=1) or deactivation (b=0)<br>(n is 1 or 2 for the respective analog input)<br>a1m=1 – mail alarm notification for analog input 1 is activated   |
| ans=b       | SMS alarm notification for analog input - activation (b=1) or deactivation (b=0)<br>(n is 1 or 2 for the respective analog input)<br>a1s=1 – sms alarm notification for analog input 1 is activated   |
| anp=b       | HTTP post alarm notification for analog input - activation (b=1) or deactivation (b=0)<br>(n is 1 or 2 for the respective analog input)   |



|                 |  |
|-----------------|--|
|                 | a2p=1 – HTTP post alarm notification for analog input 2 is activated   |
| anq=b           | MQTT alarm notification for analog input - activation (b=1) or deactivation (b=0)<br>(n is 1 or 2 for the respective analog input)<br>a2q=1 – MQTT alarm notification for analog input 2 is activated                |
| arn=x           | Return notification for analog inputs - activation (x=1) or deactivation (x=0)   |
| delanl=xxxx     | Notification delay for analog inputs<br>(xxxx is between 0 and 3600)   |
| dsn=x           | Select digital alarm state to Low level(x=0) or High level(x=1)<br>(n is 1 or 2 for the respective digital input)  |
| ddan=xxxx       | Low to high delay for digital input n<br>(n is 1 or 2 for the respective digital input)<br>(xxxx is between 0 and 3600)  |
| dddn=xxxx       | High to low delay for digital input n<br>(n is 1 or 2 for the respective digital input)<br>(xxxx is between 0 and 3600)  |
| dnm=b           | Mail alarm notification for digital input - activation (b=1) or deactivation (b=0)<br>(n is 1 or 2 for the respective digital input)<br>d1m=1 – mail alarm notification for digital input 1 is activated             |
| dns=b           | SMS alarm notification for digital input - activation (b=1) or deactivation (b=0)<br>(n is 1 or 2 for the respective digital input)<br>d1s=1 – SMS alarm notification for digital input 1 is activated               |
| dnp=b           | HTTP post alarm notification for digital input - activation (b=1) or deactivation (b=0)<br>(n is 1 or 2 for the respective digital input)<br>d2p=0 – HTTP post alarm notification for digital input 2 is deactivated |
| dnq=b           | MQTT alarm notification for digital input - activation (b=1) or deactivation (b=0)<br>(n is 1 or 2 for the respective digital input)<br>d2p=1 – MQTT alarm notification for digital input 2 is activated             |
| drn=x           | Return notification for digital inputs - activation (x=1) or deactivation (x=0)  |
| deldig=xxxx     | Notification delay for digital inputs<br>(xxxx is between 0 and 3600)  |
| <b>System</b>   |  |
| APN=xxx         | Set APN for data connection  |
| authmod =x      | Set authentication mode for data connection – None(x=0), PAP(x=1), CHAP(x=2), PAP or CHAP(x=3)   |
| APNU=xxx        | Set username authentication for data connection  |
| APNP=xxx        | Set password authentication for data connection  |
| aren=x          | Enable(x=1)/disable(x=0) automatic network connection reset  |
| timers=hh:mm:ss | Time of automatic network connection reset (hh:mm:ss)  |
| tu=x            | Set temperature units – Celsius(x=0)/ Fahrenheit(x=1)  |
| pu=x            | Set pressure units – hPa(x=0), mbar(x=1) or mmhg(x=2)  |
| hn=xxx          | Set host name - xxx, max 15 symbols  |

|                  |  |
|------------------|--|
| wm=x             | Set writing mode - left-to-right(x=0) or right-to-left(x=1)  |
| sn=xxx           | Set system name – xxx, max 31 symbols  |
| sl=xxx           | Set system location – xxx, max 31 symbols  |
| sc=xxx           | Set system contact – xxx, max 31 symbols   |
| <b>Time</b>      |  |
| TS=xxx           | Time server URL – xxx=IP/URL:port, max 36 symbols  |
| TZ=hh:mm         | Time zone – hh:mm<br>TZ=+03:00   |
| interval1=x      | NTP time synchronization interval, hours<br>interval1=12 - NTP time synchronization interval 12 hours  |
| interval2=x      | Repeat NTP time synchronization if not found, hours<br>Interval2=1 – repeat NTP synchronization if not found after 1 hour                                      |
| <b>HTTP post</b> |  |
| pmet=x           | HTTP post disable (x=0) or enable (x=1)  |
| pDrv=x           | HTTP post mode – http (x=2) or https (x=3)   |
| dataf=x          | Data format XML/JSON for HHTTP Post – 0 XML, 1 JSON  |
| purl=yyy         | URL for XML/JSON HTTP Post to Server 1, where yyy is a full path to php file<br>purl=212.25.45.120:30181/xampp/test/pushtest.php                               |
| purl2=yyy        | URL for XML/JSON HTTP Post to Server 2, where yyy is a full path to php file<br>purl=212.25.45.120:30181/xampp/test/pushtest.php                               |
| pper=x           | XML/JSON HTTP Post period in seconds<br>(x is between 60 and 172800)<br>pper=600 – will set Post period to 600 seconds   |
| pperh=hh:mm:ss   | XML/JSON HTTP Post period in format hh:mm:ss<br>pperh=00:30:00 – will set Post period on 30 minutes  |
| dk=xxx           | XML/JSON HTTP Post key – xxx is up to 17 characters  |
| pans=x           | Process answer - No (x=0) or Yes (x=1)   |
| <b>MQTT</b>      |  |
| mqttten=x        | MQTT service disable (x=0) or enable (x=1)   |
| mdata=x          | Data format JSON/Plain text for MQTT Publish – JSON (x=0) or Plain text (x=1)  |
| mmode=x          | Publish protocol, where x is 0 for unsecure and 1 for TLS/SSL  |
| murl=xxx         | URL for MQTT publish – xxx=IP/URL, max 63 symbols  |
| mport=xxxx       | Port for MQTT publish, where xxxx is a port  |
| muser=xxxx       | Username authentication for MQTT, where xxxx is a username   |
| mpass=xxxx       | Password authentication for MQTT, where xxxx is a password   |
| mper=xxx         | MQTT publish period in seconds<br>(x is between 60 and 172800)<br>mper=600 – will set MQTT publish period to 600 seconds                                       |
| nametopic=xxx    | MQTT main topic name   |
| senstopic=xxx    | MQTT sensors topic name  |
| stdny=xxx        | MQTT sensor <b>n</b> part <b>y</b> topic name, where <b>n</b> is a sensor number and <b>y</b> is a sensor part<br>std21=21, set topic name for sensor 2 part 1 |
| antopic=xxx      | MQTT analog inputs topic name  |
| atdn=xxx         | MQTT analog input <b>n</b> topic name<br>atd1=1, set analog input 1 topic name   |
| digtopic=xxx     | MQTT digital inputs topic name   |
| dtdn=xxx         | MQTT digital input <b>n</b> topic name   |

|                    |   |
|--------------------|---|
|                    | dtd1=1, set digital input 1 topic name  |
| <b>Geolocation</b> |   |
| glocen=x           | Geolocation service disable (x=0) or enable (x=1)   |
| glpr=x             | Geolocation provider – Unwiredlabs (x=0) or Google (x=2)  |
| glurl=xxx          | Geolocation server URL  |
| token=xxx          | Token / API key   |
| glper=xx           | Geolocation period request, where <b>xx</b> are seconds from 60 to 14400  |
| save               | Save all previous changes (except relays' one) in the FLASH memory.<br><b>As every save reflects the FLASH cycles (endurance), this command should be used very carefully.</b><br>pper=120&save – will set Post period to 120 seconds and save it |
| FIN                | Terminate the session   |

Multiply commands are sent concatenated with “&”.

The commands are sent in the answer on XML/JSON or CSV HTTP Posts. They are executed if “Process Answer” is enabled.

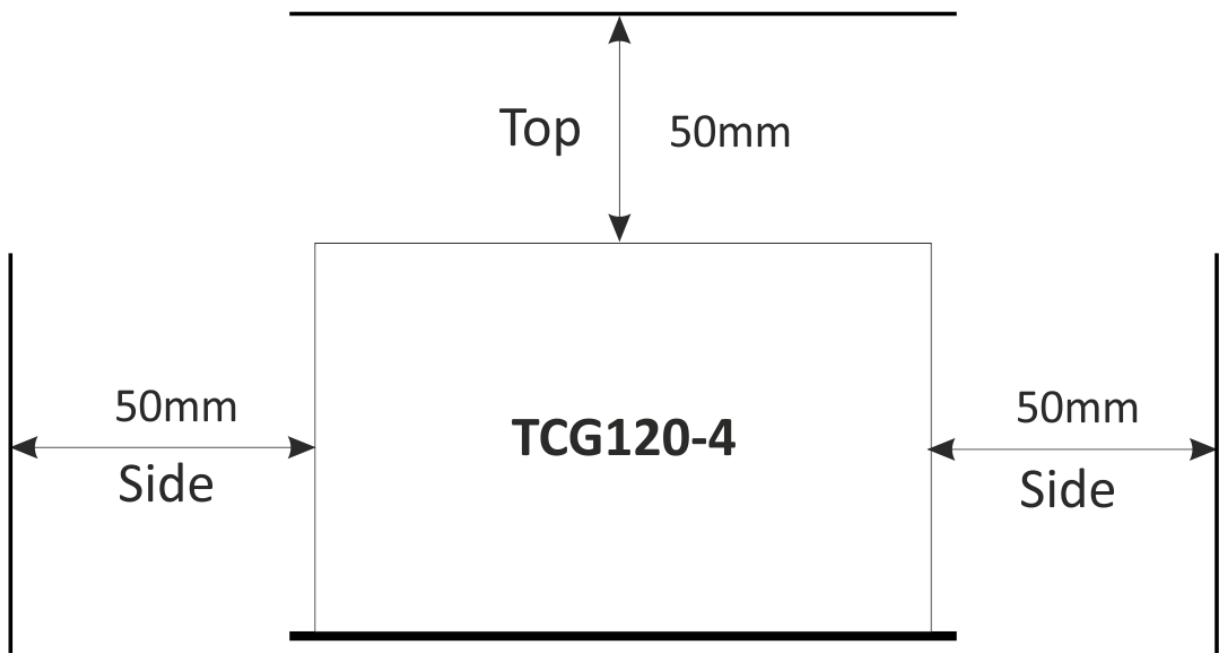

Fig.1

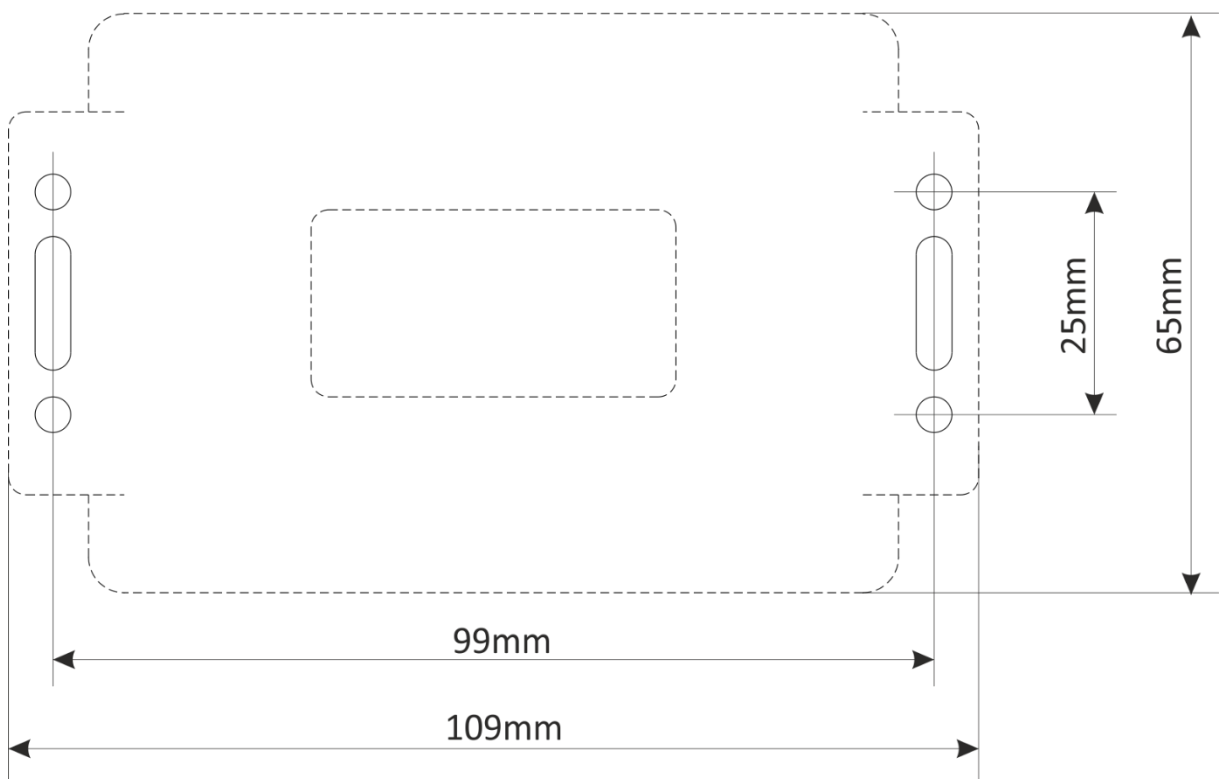

Fig.2