



















Car shelter / Autotelk / Pressutalli 3.3X6m

Detail		Quantity, kogus, määrä
A		4
B		12
C		6
D		2
E		8
F		8
G		5
H		10
I		4
J		12
K		2
L		4
		4
		8
		82
		12
		70
		1

EN. We recommend making a wooden base frame for the car shelter (for example, 50 × 100 mm or 100 × 100 mm rectangular timber), which is firmly attached to the ground with poles. This ensures that the car shelter is windproof.

Assemble the frame of the car shelter according to the drawing.

EST. Soovitame autotelgile valmistada alusraam puidust (näiteks 50x100mm või 100x100mm pruss), mis on omakorda tugevalt kinnitatud vaiadega pinnase klüge. See tagab autotelgi tuulekindluse.

Koostage autotelgi karkass vastavalt joonisele.

FI. Suosittelemme rakentamaan pressutallille puualustan (esim. 50 x 100 mm tai 100 x 100 mm palkki), joka kiinnitetään tukevasti paaluilla maanpintaan. Se takaa pressuteltan tuulenpitävyyden.

Kokoa pressuteltan runko kuvan mukaan.

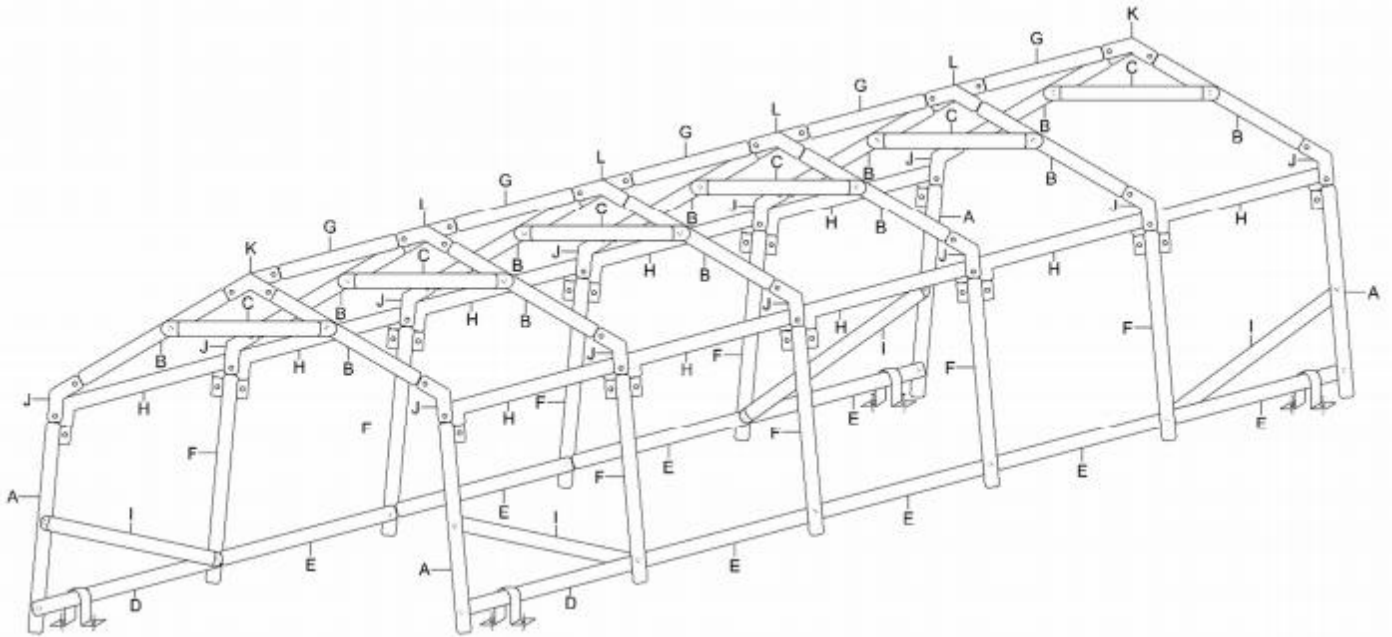

EN. Connect the frame connections as shown in the figure. Then, firmly attach the frame to the base frame. After that, install the cover. Place the cover on the roof from the side of one entrance and then begin to spread the cover evenly over the roof. Be careful with sharp tools to avoid damaging the coating. Tie the cover and tighten it to the lower frame using a rope.

EST. Ühendage karkassi torud ja ühendused, nagu joonisel on näidatud. Siis kinnitage karkass tugevalt alusraamile. Seejärel paigaldage kate. Asetage kate ühe sissepääsu pooltkatusele ja siis hakake katet ühtlaselkatusele laotama. Olge ettevaatlikud teravate tööriistadega, et ei vigata katet. Kate siduge ja pingutage kõiega alumise raamikülge.

FI. Yhdistä rungon putket ja liitännät, kuten kuvassa on näytetty. Kiinnitä runko sitten tukevasti pohjakehykseen. Asenna sitten peite. Laite peite yhden sisäänpääsyn luota katolle ja ala levittää peitettä yhtenäisesti katolle. Käytä teräviä työkaluja varovasti, jotta et vahingoita peitettä. Sido ja kiristä peite köydellä alarunkoon.

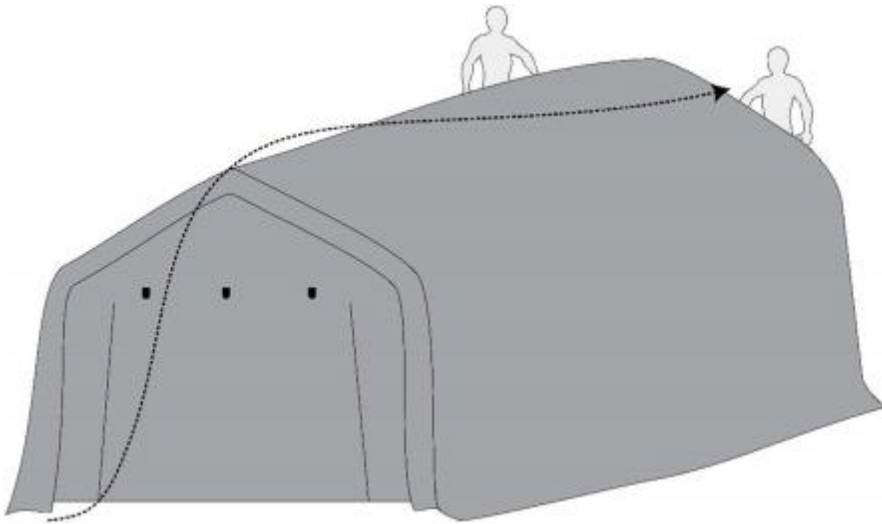

EN. Caution:

- The maximum wind resistance of the car shelter is 30 mph.
- Remove the snow accumulated on the roof of the shelter during the winter.
- Do not use an open flame in the car shelter.

EST. Ettevaatust:

- . Maksimaalne autotelgi tuulekindlus 30mph.
- . Eemaldage talvel katusele kogunenud lumi.
- . Ärge kasutage lahtist tuld autotelgis.

FI. Varoitus:

- pressuteltan enimmäistuulenkestävyys on 30 mph.
- poista talvella katolle kertyvä lumi.
- älä käytä avotulta pressuteltassa.